

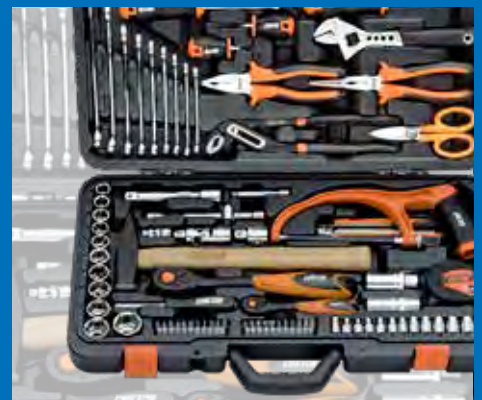

SELECTIEMAGAZINE | 24 |

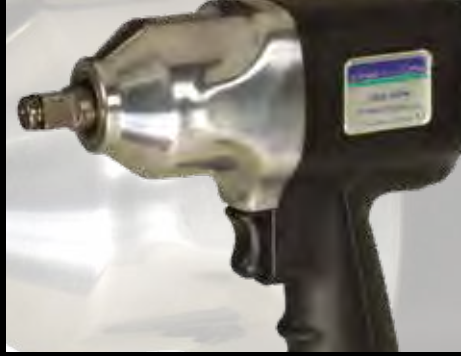

DELTACH FÜR SPITZENLEISTUNG

CUSTOR

STEINER AIR TOOLS



Alle prijzen zijn excl. BTW, wijzigingen voorbehouden.

006 GEREEDSCHAPSWAGENS **014 COMPACT/ XL**

- Compact en XL (leeg)
- Compact 3 en 5 laden gevuld
- Compact 5 laden gevuld in FOAM
- XL 3, 5 en 6 laden gevuld
- XL 5 en 6 laden gevuld in FOAM



015 FOAM INLAY AIR TOOLS **016 WERKPLAATS TROLLEYS**

- FOAM inlay met persluchtgereedschap
- FOAM inlay met krachtdoppen
- Werkplaats trolleys



016 GEREEDSCHAPSMODULES **023 FOAM MODULES**

- Gereedschapsmodules
- Momentsleutels
- Lege FOAM modules
- Lege hardschalige modules



023 GEREEDSCHAPSKOFFERS **027 DOPPENSETS**

- Ratelsleutels
- Doppenrails en -sets
- Gereedschapskoffers
- Torx
- Inbus
- Ribe
- Veeltand
- Mobiele koffer HD



028 ONDERDELEN **033 DIVERSEN**

- Losse doppen (van 1/4" t/m 1")
- Steek/ ringsleutels
- Schroevendraaiers
- T sleutels
- Tangen
- Zagen
- Snijden
- Carrosserie
- Rolmaat



034 RATELS

036 SLAGMOERSLEUTELS

- 1/4" Ratels
- 3/8" Ratels en slagratels
- 1/2" Ratels en slagratels
- 1/4" Slagmoersleutels
- 3/8" Slagmoersleutels
- 1/2" Slagmoersleutels
- 3/4" Slagmoersleutels
- 1" Slagmoersleutels



037 BOORMACHINES

038 SCHROEVENDRAAIERS

- Boormachines 6 mm
- Boormachines 10 mm
- Boormachines 13 mm
- Haakse boormachines
- Rechte boormachines
- Balancers
- Boorkoppen
- Schroevendraaiers



039 SCHUUR- EN SLIJPMACHINES

043 TOEBEHOREN

- Mini schuurmachine Ø50-75mm
- Schuurmachine Ø150mm
- Stofzak met slang
- Bandschuurmachines
- Mini slijpmachine
- Eenhandslijper
- Schuurpapier
- Schuurbanden
- Lamellenschijven



044 STIFT- EN HAAKSE SLIJERS

047 TOEBEHOREN

- Rechte stiftslijpers
- Haakse stiftslijpers
- Lange stiftslijpers
- Bandopruw machine
- Stiftrezen 3-6mm
- Mini haakse slijper
- Haakse slijpers
- Doorslijpers Ø75mm
- Rechte slijpers Ø100mm



048 STEUNPADS

049 POETSSPONZEN

- Steunpads Ø50mm
- Steunpads Ø75mm
- Steunpads Ø125mm
- Steunpads Ø150mm
- Steunpads Ø203mm
- Steunpads roloc Ø50mm
- Steunpads roloc Ø75mm
- Poetssponzen Ø80mm
- Poetssponzen Ø150mm



078 BOREN/ TAPPEN

083 ONTBRAMEN

- Spiraalboren
- Plaatboren
- Puntlasboren
- Draadsnijsets
- Trappenboren
- Verzinkfrezen
- Gatenzagen
- Machinetappen
- Tappensets
- Draadreparatie sets



084 GARAGE KRIKS

087 WERKPLAATS EQUIPMENT

- Garagekriks
- Luchthydraulische kriks
- Potkriks
- Assteunen
- Transmissiekrik
- Werkplaatskraan
- Werkplaatshulpen



088 GEREEDSCHAPSWAGENS

101 ACCESSOIRES/ TROLLEYS

- Compact Size 3, 5 laden gevuld (+FOAM)
- KING Size 3, 4, 5 laden gevuld
- KING Size 4, 5 laden gevuld in FOAM
- DE LUXE 5 laden gevuld (+ FOAM)
- Accessoires/ Perslucht/ Krachtdoppen

CUSTOR



102 GEREEDSCHAP

117 MODULES EN KOFFERS

- Ratels
- Momentsleutels
- Gereedschapsmodules
- Lege modules
- Gereedschap koffers

CUSTOR



118 ONDERDELEN

122 LOS GEREEDSCHAP

- Doppen 1/4", 3/8", 1/2", 3/4", 1"
- Tangen
- Steek-/ steekring-/ steekringratelsleutels
- Schroevendraaiers/ T- sleutels
- Overig

CUSTOR



514000

GEREEDSCHAPSWAGEN COMPACT (LEEG)

- COMPACT SIZE (lxbxh= 515x650x940mm)
- Volledig uitschuifbare, kogelgelagerde laden
- Rubber mat op werkblad
- Centraal slot
- Plaatdikte 1mm
- Compacte wielen, waarvan 2 met voetrem

- Ⓢ module: 360 x 145 x 43mm
- Ⓜ module: 435 x 90 x 43mm
- Ⓛ module: 435 x 180 x 43mm

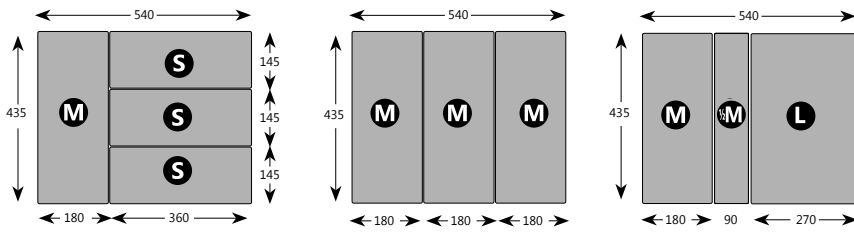

COMPACT

€ 459

515000

GEREEDSCHAPSWAGEN XL, 8 LADEN (LEEG)

- SAFETY LOCK (geen ongewenste lade opening)
- XL SIZE (lxbxh= 515x840x990mm)
- Volledig uitschuifbare, kogelgelagerde laden
- Rubber mat op werkblad
- Centraal slot
- Plaatdikte 1mm
- Grote rubber wielen, waarvan 2 met voetrem

- Ⓢ module: 360 x 145 x 43mm
- Ⓜ module: 435 x 180 x 43mm
- Ⓛ module: 435 x 270 x 43mm

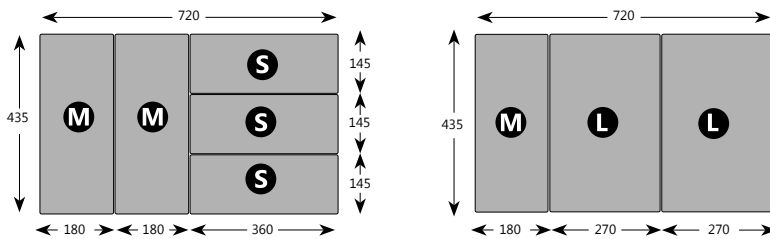

XL

€ 649

900500

SPUITBUSHOUDER



Ideaal voor het opbergen van spuitbussen, flacons, schroevendraaiers etc.

COMPACT

XL

€ 27

900510

AFVALBAK



COMPACT

XL

€ 49



514100

GEREEDSCHAPSWAGEN COMPACT, 3 LADEN GEVULD, 145DLG

Gereedschapswagen met kogelgelagerde laden (100% uitschuifbaar), rubber mat in elke lade, centraal slot, plaatdikte 1mm.

Incl. 10 modules:

140057 Doppenset 1/4", 57pcs Ratel, korte + lange doppen 4-14mm, E-torx 4-5-6-7-8-10-11mm, T10-15-20-25-27-30-40, H3-4-5-6-7-8mm, plat 4-5,5-6,5mm, PH1-2-3, PZ1-2-3, etc.

120018 Doppenset lang 1/2", 18pcs 10-11-12-13-14-15-16-17-18-19-20-21-22-23-24-27-30-32mm

120025 Doppenset 1/2", 25pcs Ratel, Korte doppen: 10-11-12-13-14-15-16-17-18-19-20-21-22-23-24-27-30-32mm, Bougiedoppen: 16-21mm, Verlengstukken: 125-250mm, Adaptor: 3/8"-1/2", Kniestuk

201000 Steekringsleutelset, 18pcs 6-7-8-9-10-11-12-13-14-15-16-17-18-19-20-21-22-24mm

900902 Kleine module leeg

311000 Schroevendraaierset, 8pcs Plat 3-4-5,5-6,5mm, PH 0-1-2-3

412000 Hamer en pendrijverset, 8pcs Hamer 500gr, kunststof hamer 500gr, beitel, centerpunter, pendrijver 2-3-4-5mm

421100 Borgring tangenset, 4pcs Recht open, recht dicht, haaks open, haaks dicht

422100 Tangenset, 3pcs Zijkniptang, combinatietang, punttang

423100 Tangenset, 3pcs Verstelbare moersleutel, waterpomptang, klemtang

COMPACT



3

- COMPACT SIZE (lxbxh= 515x650x940mm)
- Volledig uitschuifbare, kogelgelagerde laden
- Rubber mat op werkblad
- Centraal slot
- Plaatdikte 1mm
- Compacte wielen, waarvan 2 met voetrem

€ 899

514150

GEREEDSCHAPSWAGEN COMPACT, 5 LADEN GEVULD, 214DLG

Gereedschapswagen met kogelgelagerde laden (100% uitschuifbaar), rubber mat in elke lade, centraal slot, plaatdikte 1mm.

Incl. 16 modules:

140057 Doppenset 1/4", 57pcs Ratel, korte + lange doppen 4-14mm, E-torx 4-5-6-7-8-10-11mm, T10-15-20-25-27-30-40, H3-4-5-6-7-8mm, plat 4-5,5-6,5mm, PH1-2-3, PZ1-2-3, etc.

120018 Doppenset lang 1/2", 18pcs 10-11-12-13-14-15-16-17-18-19-20-21-22-23-24-27-30-32mm

120025 Doppenset 1/2", 25pcs Ratel, Korte doppen: 10-11-12-13-14-15-16-17-18-19-20-21-22-23-24-27-30-32mm, Bougiedoppen: 16-21mm, Verlengstukken: 125-250mm, Adaptor: 3/8"-1/2", Kniestuk

201000 Steekringsleutelset, 18pcs 6-7-8-9-10-11-12-13-14-15-16-17-18-19-20-21-22-24mm

900902 Kleine module leeg

311000 Schroevendraaierset, 8pcs Plat 3-4-5,5-6,5mm, PH 0-1-2-3

412000 Hamer en pendrijverset, 8pcs Hamer 500gr, kunststof hamer 500gr, beitel, centerpunter, pendrijver 2-3-4-5mm

421100 Borgring tangenset, 4pcs Recht open, recht dicht, haaks open, haaks dicht

422100 Tangenset, 3pcs Zijknijptang, combinatietang, punttang

423100 Tangenset, 3pcs Verstelbare moersleutel, waterpomptang, klemtang

414000 Vijlenset, 5pcs Plat, vierkant, driehoek, halfrond, rond

315100 Inbus T-Sleutel set, 8pcs H2-2,5-3-4-5-6-7-8mm

316100 Torx T-Sleutel set, 9pcs T10-15-20-25-27-30-40-45-50

411000 Set mes, schaar, zaag, 3pcs Incl. 4 extra zaagbladen en 4 mes navullingen

126000 Doppenset E-torx, 18pcs Kort: E10-11-12-14-16-18-20-22-24mm Lang: E10-11-12-14-16-18-20-22-24mm

127000 Doppenset veeltand 12-kant/ribe kort, 1/2", 19pcs Spline: M5-6-7-8-9-10-12-14-16 Ribe: M5-6-7-8-9-10-11-12-13-14

207000 Kniesleutelset, 8pcs 6x7 - 8x9 - 10x11 - 12x13 - 14x15 - 16x17 - 18x19 - 20x22mm

- COMPACT SIZE (lxbxh= 515x650x940mm)
- Volledig uitschuifbare, kogelgelagerde laden
- Rubber mat op werkblad
- Centraal slot
- Plaatdikte 1mm
- Compacte wielen, waarvan 2 met voetrem



5

COMPACT



€ 1149

514250

GEREEDSCHAPSWAGEN COMPACT, 5 LADEN GEVULD IN FOAM, 214DLG

COMPACT

Gereedschapswagen met kogelgelagerde laden (100% uitschuifbaar), rubber mat in elke lade, centraal slot, plaatdikte 1mm.

Incl. 16 modules:

140057 Doppenset 1/4", 57pcs Ratel, korte + lange doppen 4-14mm, E-torx 4-5-6-7-8-10-11mm, T10-15-20-25-27-30-40, H3-4-5-6-7-8mm, plat 4-5,5-6,5mm, PH1-2-3, PZ1-2-3, etc.

120018 Doppenset lang 1/2", 18pcs 10-11-12-13-14-15-16-17-18-19-20-21-22-23-24-27-30-32mm

120025 Doppenset 1/2", 25pcs Ratel, Korte doppen: 10-11-12-13-14-15-16-17-18-19-20-21-22-23-24-27-30-32mm, Bougiedoppen: 16-21mm, Verlengstukken: 125-250mm, Adaptor: 3/8"-1/2", Kniestuk

201000 Steekringsleutelset, 18pcs 6-7-8-9-10-11-12-13-14-15-16-17-18-19-20-21-22-24mm

423100 Tangenset, 3pcs Verstelbare moersleutel, waterpomptang, klemtang

311000 Schroevendraaierset, 8pcs Plat 3-4-5,5-6,5mm, PH 0-1-2-3

412000 Hamer en pendrijverset, 8pcs Hamer 500gr, kunststof hamer 500gr, beitel, centerpunter, pendrijver 2-3-4-5mm

421100 Borgring tangenset, 4pcs Recht open, recht dicht, haaks open, haaks dicht

422100 Tangenset, 3pcs Zijknijptang, combinatietang, punttang

414000 Vijlenset, 5pcs Plat, vierkant, driehoek, half rond, rond

315100 Inbus T-Sleutel set, 8pcs H2-2,5-3-4-5-6-7-8mm

316100 Torx T-Sleutel set, 9pcs T10-15-20-25-27-30-40-45-50

411000 Set mes, schaar, zaag, 3pcs Incl. 4 extra zaagbladen en 4 mes navullingen

126000 Doppenset E-torx, 18pcs Kort: E10-11-12-14-16-18-20-22-24mm Lang: E10-11-12-14-16-18-20-22-24mm

127000 Doppenset veeltand 12-kant/ribe kort, 1/2", 19pcs Spline: M5-6-7-8-9-10-12-14-16 Ribe: M5-6-7-8-9-10-11-12-13-14

207000 Kniesleutelset, 8pcs 6x7 - 8x9 - 10x11 - 12x13 - 14x15 - 16x17 - 18x19 - 20x22mm

- COMPACT SIZE (lxbxh= 515x650x940mm)
- Volledig uitschuifbare, kogelgelagerde laden
- Rubber mat op werkblad
- Centraal slot
- Plaatdikte 1mm
- Compacte wielen, waarvan 2 met voetrem

FOAM
INLAY

INHOUD
IDEM
514150

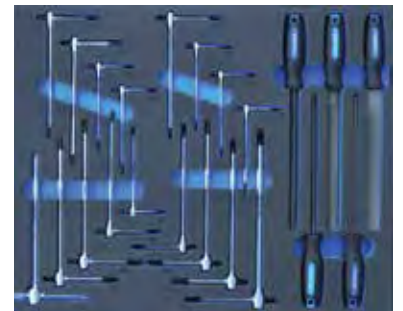

€ 1349

515100

GEREEDSCHAPSWAGEN XL, 3 LADEN GEVULD, 227DLG

Incl 12 modules:

140057 Doppenset 1/4", 57pcs Ratel, korte + lange doppen 4-14mm, E-torx 4-5-6-7-8-10-11mm, T10-15-20-25-27-30-40, H3-4-5-6-7-8mm, plat 4-5,5-6,5mm, PH1-2-3, PZ1-2-3, etc.

130071 Doppenset 3/8", 71pcs Ratel, korte + lange doppen 6-22mm, bougiedoppen 16-21mm, E-torx 10-11-12-14-16-18-20mm, T10-15-20-25-30-40-45-50-55, H5-6-7-8-10mm, plat 5,5-6,5mm, PH1-2-3, PZ1-2-3, etc.

201000 Steekringsleutelset, 18pcs 6-7-8-9-10-11-12-13-14-15-16-17-18-19-20-21-22-24mm

120025 Doppenset 1/2", 25pcs Ratel, Korte doppen: 10-11-12-13-14-15-16-17-18-19-20-21-22-23-24-27-30-32mm, Bougiedoppen: 16-21mm, Verlengstukken: 125-250mm, Adaptor: 3/8"-1/2", Kniestuk.

120018 Doppenset lang 1/2", 18pcs 10-11-12-13-14-15-16-17-18-19-20-21-22-23-24-27-30-32mm

313000 Torx schroevendraaierset, 8 pcs T8-10-15-20-25-27-30-40

311000 Schroevendraaierset, 8pcs Plat 3-4-5,5-6,5mm, PH 0-1-2-3

411000 Set mes, schaar, zaag, 3pcs Incl. 4 extra zaagbladen en 4 mes navullingen

412000 Hamer en pendrijverset, 8pcs Hamer 500gr, kunststof hamer 500gr, beitel, centerpunter, pendrijver 2-3-4-5mm

421100 Borgring tangenset, 4pcs Recht open, recht dicht, haaks open, haaks dicht

422100 Tangenset, 3pcs Zijknijptang, combinatietang, punttang

423100 Tangenset, 3pcs Verstelbare moersleutel, waterpomptang, klemtang



- SAFETY LOCK (geen ongewenste lade opening)
- XL SIZE (lxbxh= 515x840x990mm)
- Volledig uitschuifbare, kogelgelagerde laden
- Rubber mat op werkblad
- Centraal slot
- Plaatdikte 1mm
- Grote rubber wielen, waarvan 2 met voetrem

€ 1299

515150

GEREEDSCHAPSWAGEN XL, 5 LADEN GEVULD, 350DLG

Incl 21 modules:

140057 Doppenset 1/4", 57pcs Ratel, korte + lange doppen 4-14mm, E-torx 4-5-6-7-8-10-11mm, T10-15-20-25-27-30-40, H3-4-5-6-7-8mm, plat 4-5,5-6,5mm, PH1-2-3, PZ1-2-3, etc.

130071 Doppenset 3/8", 71pcs Ratel, korte + lange doppen 6-22mm, bougiedoppen 16-21mm, E-torx 10-11-12-14-16-18-20mm, T10-15-20-25-30-40-45-50-55, H5-6-7-8-10mm, plat 5,5-6,5mm, PH1-2-3, PZ1-2-3, etc.

201000 Steekringsleutelset, 18pcs 6-7-8-9-10-11-12-13-14-15-16-17-18-19-20-21-22-24mm

120025 Doppenset 1/2", 25pcs Ratel, Korte doppen: 10-11-12-13-14-15-16-17-18-19-20-21-22-23-24-27-30-32mm, Bougiedoppen: 16-21mm, Verlengstukken: 125-250mm, Adaptor: 3/8"-1/2", Kniestuk

120018 Doppenset lang 1/2", 18pcs 10-11-12-13-14-15-16-17-18-19-20-21-22-23-24-27-30-32mm

313000 Torx schroevendraaierset, 8 pcs T8-10-15-20-25-27-30-40

311000 Schroevendraaierset, 8pcs Plat 3-4-5,5-6,5mm, PH 0-1-2-3

411000 Set mes, schaar, zaag, 3pcs Incl. 4 extra zaagbladen en 4 mes navullingen

412000 Hamer en pendrijverset, 8pcs Hamer 500gr, kunststof hamer 500gr, beitel, centerpunter, pendrijver 2-3-4-5mm

421100 Borgring tangenset, 4pcs Recht open, recht dicht, haaks open, haaks dicht

422100 Tangenset, 3pcs Zijknijptang, combinatietang, punttang

423100 Tangenset, 3pcs Verstelbare moersleutel, waterpomp tang, klemtang

207000 Kniesleutelset, 8pcs 6x7 - 8x9 - 10x11 - 12x13 - 14x15 - 16x17 - 18x19 - 20x22mm

126000 Doppenset E-torx, 18pcs Kort : E10-11-12-14-16-18-20-22-24mm Lang: E10-11-12-14-16-18-20-22-24mm

127000 Doppenset veeltand 12-kant/ribe kort, 1/2", 19pcs Spline: M5-6-7-8-9-10-12-14-16 Ribe: M5-6-7-8-9-10-11-12-13-14

124000 Doppenset inbus 1/2", 22pcs Kort : 4-5-6-7-8-9-10-12-14-17-19mm. Lang: 4-5-6-7-8-9-10-12-14-17-19mm

122000 Doppenset torx 1/2", 18pcs Kort : T20-25-27-30-40-45-50-55-60 Lang: T20-25-27-30-40-45-50-55-60

315100 Inbus T-Sleutel set, 8pcs H2-2,5-3-4-5-6-7-8mm

316100 Torx T-Sleutel set, 9pcs T10-15-20-25-27-30-40-45-50

212000 Steekring ratelsleutelset L-R, 12pcs 8-9-10-11-12-13-14-15-16-17-18-19mm

203000 Gebogen ringsleutelset, 10pcs 6x7 - 8x9 - 10x11 - 12x13 - 14x15 - 16x17 - 18x19 - 20x22 - 24x27 - 30x32mm



140057 130071 201000



120025 120018 313000 311000



411000 412000 421100

422100

423100



207000 126000 127000



315100 316100 212000 203000



- SAFETY LOCK (geen ongewenste lade opening)
- XL SIZE (lxbxh= 515x840x990mm)
- Volledig uitschuifbare, kogelgelagerde laden
- Rubber mat op werkblad
- Centraal slot
- Plaatdikte 1mm
- Grote rubber wielen, waarvan 2 met voetrem

€ 1780

515160

GEREEDSCHAPSWAGEN XL, 6 LADEN GEVULD, 378DLG

Incl 26 modules:

140057 Doppenset 1/4", 57pcs Ratel, korte + lange doppen 4-14mm, E-torx 4-5-6-7-8-10-11mm, T10-15-20-25-27-30-40, H3-4-5-6-7-8mm, plat 4-5,5-6,5mm, PH1-2-3, PZ1-2-3, etc.

130071 Doppenset 3/8", 71pcs Ratel, korte + lange doppen 6-22mm, bougiedoppen 16-21mm, E-torx 10-11-12-14-16-18-20mm, T10-15-20-25-30-40-45-50-55, H5-6-7-8-10mm, plat 5,5-6,5mm, PH1-2-3, PZ1-2-3, etc.

201000 Steekringsleutelset, 18pcs 6-7-8-9-10-11-12-13-14-15-16-17-18-19-20-21-22-24mm

120025 Doppenset 1/2", 25pcs Ratel, Korte doppen: 10-11-12-13-14-15-16-17-18-19-20-21-22-23-24-27-30-32mm, Bougiedoppen: 16-21mm, Verlengstukken: 125-250mm, Adaptor: 3/8"-1/2", Kniestuk

120018 Doppenset lang 1/2", 18pcs 10-11-12-13-14-15-16-17-18-19-20-21-22-23-24-27-30-32mm

313000 Torx schroevendraaierset, 8 pcs T8-10-15-20-25-27-30-40

311000 Schroevendraaierset, 8pcs Plat 3-4-5,5-6,5mm, PH 0-1-2-3

411000 Set mes, schaar, zaag, 3pcs Incl. 4 extra zaagbladen en 4 mes navullingen

412000 Hamer en pendrijverset, 8pcs Hamer 500gr, kunststof hamer 500gr, beitel, centerpunter, pendrijver 2-3-4-5mm

421100 Borgring tangenset, 4pcs Recht open, recht dicht, haaks open, haaks dicht

422100 Tangenset, 3pcs Zijkniptang, combinatietang, punttang

423100 Tangenset, 3pcs Verstelbare moersleutel, waterpomp tang, klemtang

207000 Kniesleutelset, 8pcs 6x7 - 8x9 - 10x11 - 12x13 - 14x15 - 16x17 - 18x19 - 20x22mm

126000 Doppenset E-torx, 18pcs Kort : E10-11-12-14-16-18-20-22-24mm Lang: E10-11-12-14-16-18-20-22-24mm

127000 Doppenset veeltand 12-kant/ribe kort, 1/2", 19pcs Spline: M5-6-7-8-9-10-12-14-16 Ribe: M5-6-7-8-9-10-11-12-13-14

124000 Doppenset inbus 1/2", 22pcs Kort : 4-5-6-7-8-9-10-12-14-17-19mm. Lang: 4-5-6-7-8-9-10-12-14-17-19mm

122000 Doppenset torx 1/2", 18pcs Kort : T20-25-27-30-40-45-50-55-60 Lang: T20-25-27-30-40-45-50-55-60

315100 Inbus T-Sleutel set, 8pcs H2-2,5-3-4-5-6-7-8mm

316100 Torx T-Sleutel set, 9pcs T10-15-20-25-27-30-40-45-50

212000 Steekring ratelsleutelset L-R, 12pcs 8-9-10-11-12-13-14-15-16-17-18-19mm

203000 Gebogen ringsleutelset, 10pcs 6x7 - 8x9 - 10x11 - 12x13 - 14x15 - 16x17 - 18x19 - 20x22 - 24x27 - 30x32mm

201001 Steekringsleutelset XL, 3pcs 27-30-32mm

414000 Vijlenset, 5pcs Plat, vierkant, driehoek, halfmond, rond

428000 Tangenset extra lang, 3pcs Bougiekaptang, punttang, punttang gebogen

415000 Meet en pick-up gereedschapset, 7pcs Diverse meetgereedschappen

138000 3/8" Bougie/ gloeibougie doppenset, 10pcs 14, 16, 18, 21mm, met kniegewricht: 8, 9, 10, 12, 14, 16mm



- SAFETY LOCK (geen ongewenste lade opening)
- XL SIZE (lxbxh= 515x840x990mm)
- Volledig uitschuifbare, kogelgelagerde laden
- Rubber mat op werkblad
- Centraal slot
- Plaatdikte 1mm
- Grote rubber wielen, waarvan 2 met voetrem



140057 130071 201000



120025 120018 313000 311000



411000 412000 421100 422100 423100



207000 126000 127000



315100 316100 212000 203000



201001 414000 415000 138000 428000

€ 1980

515250

GEREEDSCHAPSWAGEN XL, 5 LADEN GEVULD IN FOAM, 350DLG

Incl 21 modules:

130071 Doppenset 3/8", 71pcs Ratel, korte + lange doppen 6-22mm, bougiedoppen 16-21mm, E-torx 10-11-12-14-16-18-20mm, T10-15-20-25-30-40-45-50-55, H5-6-7-8-10mm, plat 5,5-6,5mm, PH1-2-3, PZ1-2-3, etc.

140057 Doppenset 1/4", 57pcs Ratel, korte + lange doppen 4-14mm, E-torx 4-5-6-7-8-10-11mm, T10-15-20-25-27-30-40, H3-4-5-6-7-8mm, plat 4-5,5-6,5mm, PH1-2-3, PZ1-2-3, etc.

201000 Steekringsleutelset, 18pcs 6-7-8-9-10-11-12-13-14-15-16-17-18-19-20-21-22-24mm

313000 Torx schroevendraaierset, 8 pcs T8-10-15-20-25-27-30-40

311000 Schroevendraaierset, 8pcs Plat 3-4-5,5-6,5mm, PH 0-1-2-3

120025 Doppenset 1/2", 25pcs Ratel, Korte doppen: 10-11-12-13-14-15-16-17-18-19-20-21-22-23-24-27-30-32mm, Bougiedoppen: 16-21mm, Verlengstukken: 125-250mm, Adaptor: 3/8"-1/2", Kniestuk

120018 Doppenset lang 1/2", 18pcs 10-11-12-13-14-15-16-17-18-19-20-21-22-23-24-27-30-32mm

207000 Kniesleutelset, 8pcs 6x7 - 8x9 - 10x11 - 12x13 - 14x15 - 16x17 - 18x19 - 20x22mm

126000 Doppenset E-torx, 18pcs Kort: E10-11-12-14-16-18-20-22-24mm Lang: E10-11-12-14-16-18-20-22-24mm

127000 Doppenset veeltand 12-kant/ribe kort, 1/2", 19pcs Spline: M5-6-7-8-9-10-12-14-16 RIBE: M5-6-7-8-9-10-11-12-13-14

124000 Doppenset inbus 1/2", 22pcs Kort: 4-5-6-7-8-9-10-12-14-17-19mm. Lang: 4-5-6-7-8-9-10-12-14-17-19mm

122000 Doppenset torx 1/2", 18pcs Kort: T20-25-27-30-40-45-50-55-60
Lang: T20-25-27-30-40-45-50-55-60

315100 Inbus T-Sleutel set, 8pcs H2-2,5-3-4-5-6-7-8mm

316100 Torx T-Sleutel set, 9pcs T10-15-20-25-27-30-40-45-50

421100 Borgring tangenset, 4pcs Recht open, recht dicht, haaks open, haaks dicht

422100 Tangenset, 3pcs Zijknijptang, combinatietang, punttang

423100 Tangenset, 3pcs Verstelbare moersleutel, waterpomptang, klemtang

412000 Hamer en pendrijverset, 8pcs Hamer 500gr, kunststof hamer 500gr, beitel, centerpunter, pendrijver 2-3-4-5mm

411000 Set mes, schaar, zaag, 3pcs Incl. 4 extra zaagbladen en 4 mes navullingen

212000 Steekring ratsleutelset L-R, 12pcs 8-9-10-11-12-13-14-15-16-17-18-19mm

203000 Gebogen ringsleutelset, 10pcs 6x7 - 8x9 - 10x11 - 12x13 - 14x15 - 16x17 - 18x19 - 20x22 - 24x27 - 30x32mm



XL

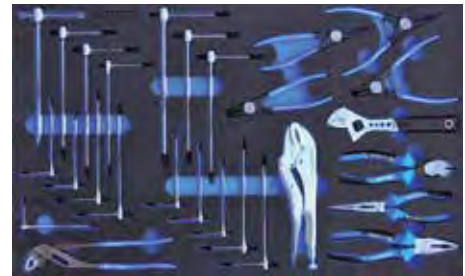

INHOUD
IDEM
515150



- SAFETY LOCK (geen ongewenste lade opening)
- XL SIZE (lxbxh= 515x840x990mm)
- Volledig uitschuifbare, kogelgelagerde laden
- Rubber mat op werkblad
- Centraal slot
- Plaatdikte 1mm
- Grote rubber wielen, waarvan 2 met voetrem

FOAM
INLAY

€ 1980

515260

GEREEDSCHAPSWAGEN XL, 6 LADEN GEVULD IN FOAM, 378DLG

Incl 26 modules:

130071 Doppenset 3/8", 71pcs Ratel, korte + lange doppen 6-22mm, bougiedoppen 16-21mm, E-torx 10-11-12-14-16-18-20mm, T10-15-20-25-30-40-45-50-55, H5-6-7-8-10mm, plat 5,5-6,5mm, PH1-2-3, PZ1-2-3, etc.

140057 Doppenset 1/4", 57pcs Ratel, korte + lange doppen 4-14mm, E-torx 4-5-6-7-8-10-11mm, T10-15-20-25-27-30-40, H3-4-5-6-7-8mm, plat 4-5,5-6,5mm, PH1-2-3, PZ1-2-3, etc.

201000 Steekringsleutelset, 18pcs 6-7-8-9-10-11-12-13-14-15-16-17-18-19-20-21-22-24mm

313000 Torx schroevendraaierset, 8 pcs T8-10-15-20-25-27-30-40

311000 Schroevendraaierset, 8pcs Plat 3-4-5,5-6,5mm, PH 0-1-2-3

120025 Doppenset 1/2", 25pcs Ratel, Korte doppen: 10-11-12-13-14-15-16-17-18-19-20-21-22-23-24-27-30-32mm, Bougiedoppen: 16-21mm, Verlengstukken: 125-250mm, Adaptor: 3/8"-1/2", Kniestuk

120018 Doppenset lang 1/2", 18pcs 10-11-12-13-14-15-16-17-18-19-20-21-22-23-24-27-30-32mm

207000 Kniesleutelset, 8pcs 6x7 - 8x9 - 10x11 - 12x13 - 14x15 - 16x17 - 18x19 - 20x22mm

126000 Doppenset E-torx, 18pcs Kort: E10-11-12-14-16-18-20-22-24mm Lang: E10-11-12-14-16-18-20-22-24mm

127000 Doppenset veeltand 12-kant/ribe kort, 1/2", 19pcs Spline: M5-6-7-8-9-10-12-14-16 Riibe: M5-6-7-8-9-10-11-12-13-14

124000 Doppenset inbus 1/2", 22pcs Kort: 4-5-6-7-8-9-10-12-14-17-19mm. Lang: 4-5-6-7-8-9-10-12-14-17-19mm

122000 Doppenset torx 1/2", 18pcs Kort: T20-25-27-30-40-45-50-55-60 Lang: T20-25-27-30-40-45-50-55-60

315100 Inbus T-Sleutel set, 8pcs H2-2,5-3-4-5-6-7-8mm

316100 Torx T-Sleutel set, 9pcs T10-15-20-25-27-30-40-45-50

421100 Borgring tangenset, 4pcs Recht open, recht dicht, haaks open, haaks dicht

422100 Tangenset, 3pcs Zijknijptang, combinatietang, punttang

423100 Tangenset, 3pcs Verstelbare moersleutel, waterpomp tang, klemtang

412000 Hamer en pendrijverset, 8pcs Hamer 500gr, kunststof hamer 500gr, beitel, centerpunter, pendrijver 2-3-4-5mm

411000 Set mes, schaar, zaag, 3pcs Incl. 4 extra zaagbladen en 4 mes navullingen

212000 Steekring ratelsleutelset L-R, 12pcs 8-9-10-11-12-13-14-15-16-17-18-19mm

203000 Gebogen ringsleutelset, 10pcs 6x7 - 8x9 - 10x11 - 12x13 - 14x15 - 16x17 - 18x19 - 20x22 - 24x27 - 30x32mm

201001 Steekringsleutelset XL, 3pcs 27-30-32mm

414000 Vijlenset, 5pcs Plat, vierkant, driehoek, halfmond, rond

428000 Tangenset extra lang, 3pcs Bougiekaptang, punttang, punttang gebogen

415000 Meet en pick-up gereedschapset, 7pcs Diverse meetgereedschappen

138000 3/8" Bougie/ gloeibougie doppenset, 10pcs 14, 16, 18, 21mm, met kniegewricht: 8, 9, 10, 12, 14, 16mm

- SAFETY LOCK (geen ongewenste lade opening)
- XL SIZE (lxbxh= 515x840x990mm)
- Volledig uitschuifbare, kogelgelagerde laden
- Rubber mat op werkblad
- Centraal slot
- Plaatdikte 1mm
- Grote rubber wielen, waarvan 2 met voetrem

INHOUD
IDEM
515160

FOAM
INLAY

€ 2195



540100

FOAM INLAY MET PERSLUCHTGEREEDSCHAP

FOAM inlay met diverse persluchtgereedschappen, past perfect in de hoge lade van alle DELTACH karren uit 515 serie. Inhoud:

SR5290N 1/2" Slagmoersleutel, 1250Nm. In 3 standen instelbaar, losdraaiend altijd volle kracht, 10.000rpm.

SK6926CM 1/2" Krachtdoppenset lang; 10 t/m 19-21-22-24mm (18mm is extra toegevoegd)

SK12E125 1/2" Verlengstuk kracht 125mm

440120 1/2" Momentsleutel 60-340Nm

SR5266 1/2" Ratel, geluidgedempt. Kunststof behuizing, laag geluidsniveau, links/rechts draaiend, 95Nm, 220rpm.

SR5251 3/8" Ratel, geluidgedempt. Kunststof behuizing, laag geluidsniveau, compacte afmetingen, links/ rechtsdraaiend, 55Nm, 310rpm.

SR1012RSS 10mm Boormachine. Met kunststof grip en snelspan boorkop, links/rechts draaiend, 1800rpm.

730002 Boorcassette 19dlg. HSS-G geslepen boren, DIN338, cilindrisch, kruisaanslijping volgens DIN1412 C, tophoek 118°.



Afm.: 720x435mm

€ 579

540200

FOAM INLAY MET 1/2" KRACHTDOPPEN, 90DLG

1/2" Krachtdoppen:

6-kant: 10-11-12-13-14-15-16-17-18-19-20-21-22-24-25-26-27-30-32-36mm

6-kant Lang: 10-11-12-13-14-15-16-17-18-19-20-21-22-24-25-26-27-30-32-36mm

6-kant Lang/ dunwandig: 15-17-19-21-22mm

12-Kant Lang: 10-11-12-13-14-15-16-17-19-21-22-24-27-30-32-36mm

Inbus: H6, H7, H8, H10, H12, H14, H17, H19

Torx: T25, T27, T30, T40, T45, T50, T55, T60

Spiraaldoppen inwendig: 17-19-21-22mm



Afm.: 720x435mm

Adaptors en verlengstukken

SK38A12 3/8" Adapter (kracht) naar 1/2"

SK12A34 1/2" Adapter (kracht) naar 3/4"

SK12A38 1/2" Adapter (kracht) naar 3/8"

SK12U12 1/2" Kniestuk (kracht)

SK12E75 1/2" Verlengstuk, (kracht) 75mm

SK12E125 1/2" Verlengstuk, (kracht) 125mm

SK12E250 1/2" Verlengstuk, (kracht) 250mm

SK34A12 3/4" Adapter (kracht) naar 1/2"

€ 399



511240

WERKPLAATSTROLLEY MET 3 SCHAPPEN

Solide werkplaats- en magazijnhulp, makkelijk manoeuvreerbaar en inzetbaar op elk terrein. Voorzien van 3 legborden. Uitgerust met 4 zwenkbare PU wielen, waarvan 2 met voetrem. Afmetingen: 790x480x875mm (lxbxh).



- 511297 Accessoire bak klein € 12,50
- 511298 Afvalbak groot € 19,50
- 511299 Spuitbushouder € 25,00

€ 139

511230

WERKPLAATSTROLLEY MET LADE EN ACHTERWAND

Solide werkplaats- en magazijnhulp, makkelijk manoeuvreerbaar en inzetbaar op elk terrein. Voorzien van lade, 3 legborden en achterwand met ophangbeugels. Uitgerust met 4 zwenkbare PU wielen, waarvan 2 met voetrem. Afmetingen: 870x490x1450mm (lxbxh).



- 529807 Ophangbeugel € 3,50
- 511297 Accessoire bak klein € 12,50
- 511298 Afvalbak groot € 19,50
- 511299 Spuitbushouder € 25,00

€ 249

511200

WERKPLAATSTROLLEY MET LADE EN LOCKER

Solide werkplaats- en magazijnhulp, makkelijk manoeuvreerbaar en inzetbaar op elk terrein. Voorzien van 1 lade (580x375x60mm) en afsluitbare locker. Uitgerust met 4 zwenkbare PU wielen, waarvan 2 met voetrem. Afmetingen: 860x470x1020mm (lxbxh).



- 529807 Ophangbeugel € 3,50
- 511297 Accessoire bak klein € 12,50
- 511298 Afvalbak groot € 19,50
- 511299 Spuitbushouder € 25,00

€ 279

511280

WERKPLAATSTROLLEY EXTRA HOOG MET LADE

Handige, solide werkplaats- en magazijnhulp met prettige werkhogte van 120cm. Handig manoeuvreerbaar en inzetbaar op elk terrein. Voorzien van lade. Uitgerust met 4 zwenkbare PU wielen, waarvan 2 met voetrem. Afmetingen: 800x480x1140mm (lxbxh).



- 529807 Ophangbeugel € 3,50
- 511297 Accessoire bak klein € 12,50
- 511298 Afvalbak groot € 19,50
- 511299 Spuitbushouder € 25,00

€ 299

140057**DOPPENSET 1/4" 57DLG M****1/4"**

Ratel, Korte doppen: 4-14mm, Lange doppen: 4-14mm E-torxdoppen: 4-5-6-7-8-10-11mm, Torx bitdoppen: T10-15-20-25-27-30-40, Inbus bitdoppen: H3-4-5-6-7-8mm, Platte schroef bitdoppen: 4-5,56,5mm, Kruiskop bitdoppen: PH1-2-3, Pozi drive bitdoppen: PZ1-2-3, Verlengstukken: 50-150mm, Wringijzer, Kniestuk, Schroevendraaier bithouder

**€ 69,50****120018****DOPPENSET 1/2", LANG, 18DLG M****1/2"**

Doppenset lang 1/2", 18dlg
10-11-12-13-14-15-16-17-18-19-20-21-22-23-24-27-30-32mm

**€ 69****130071****DOPPENSET 3/8", 71DLG L****3/8"**

Ratel, Korte doppen: 6-7-8-9-10-11-12-13-14-15-16-17-18-19-20-21-22mm,
Lange doppen: 6-7-8-9-10-11-12-13-14-15-16-17-18-19-20-21-22mm,
Bougiedoppen: 16-21mm,
E-torx doppen: 10-11-12-14-16-18-20mm,
Torx bitdoppen: T10-15-20-25-30-40-45-50-55,
Inbus bitdoppen: H5-6-7-8-10mm,
Platte schroef bitdoppen: 5,5-6,5mm,
Kruiskop bitdoppen: PH1-2-3,
Pozi drive bitdoppen PZ1-2-3,
Verlengstukken 75-150mm,
Wringijzer, Adaptor 1/2"- 3/8", Kniestuk.

**€ 125****120025****DOPPENSET 1/2", 25DLG M****1/2"**

Ratel, Korte doppen: 10-11-12-13-14-15-16-17-18-19-20-21-22-23-24-27-30-32mm,
Bougiedoppen: 16-21mm, Verlengstukken: 125-250mm,
Adaptor: 3/8"-1/2", Kniestuk.

**€ 85****122000****DOPPENSET TORX 1/2", KORT+LANG, 18PCS M****1/2"**

Kort: T20-25-27-30-40-45-50-55-60
Lang: T20-25-27-30-40-45-50-55-60

**€ 62****138000****3/8" BOUGIE/GLOEI-BOUGIE DOPPENSET, 10DLG S****3/8"**

Complete set tbv montage en demontage van bougies en gloeibougies
Recht (12-kant): 14, 16, 18, 21mm
Met kniegewricht (6-kant): 8, 9, 10, 12, 14, 16mm.

**€ 66****124000****DOPPENSET 1/2", INBUS KORT+LANG, 22DLG M****1/2"**

Kort: H4-5-6-7-8-9-10-12-14-17-19mm
Lang: H4-5-6-7-8-9-10-12-14-17-19mm

**€ 75**

126000

DOPPENSET 1/2", E-TORX,
KORT+LANG, 18DLG Ⓢ

Kort: E10-11-12-14-16-18-20-22-24mm
Lang: E10-11-12-14-16-18-20-22-24mm

1/2"

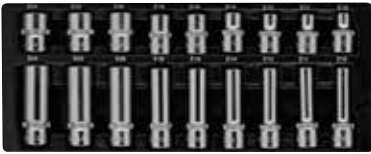

€ 55

203000

GEBOGEN RINGSLEUTELSET, 10DLG Ⓜ

6x7 - 8x9 - 10x11 - 12x13 - 14x15 - 16x17 - 18x19 -
20x22 - 24x27 - 30x32mm



€ 108

127000

DOPPENSET 1/2", VEELTAND-12KANT/RIBE,
19DLG Ⓢ

Veeltand-12kant: M5-6-7-8-9-10-12-14-16
Ribe : M5-6-7-8-9-10-11-12-13-14

1/2"



€ 63

207000

KNIESLEUTELSET, 8DLG Ⓢ

6x7 - 8x9 - 10x11 - 12x13 - 14x15 - 16x17 -
18x19 - 20x22mm



€ 79,50

201000

STEEKRINGSLEUTELSET, 18DLG Ⓛ

6-7-8-9-10-11-12-13-14-15-16-17-18-19-20-21-22-24mm



€ 109

212000

STEEKRING RATELSLEUTELSET L-R, 12DLG Ⓜ

Facet, licht gebogen
8-9-10-11-12-13-14-15-16-17-18-19mm



€ 159

201001

STEEKRINGSLEUTELSET XL, 3DLG Ⓜ

27-30-32mm



€ 65

202000

STEEKSLEUTELSET EXTRA DUN, 10DLG, Ⓜ

6x7mm, 8x9mm, 10x11mm, 12x13mm, 14x15mm, 16x17mm,
18x19mm, 20x22mm, 21x23mm, 22x24mm.



€ 79,50

311000

SCHROEVENDRAAIERSET, 8DLG

Plat: 3-4-5,5-6,5mm, PH: 0-1-2-3



€ 32,50

313000

TORX SCHROEVENDRAAIERSET, 8DLG

2 Componenten ergo grip, T8-10-15-20-25-27-30-40



€ 32,50

315100

INBUS T-SLEUTEL SET, 8DLG

Verstelbaar, H2-2,5-3-4-5-6-7-8



€ 66

422100

TANGENSET, 3DLG

2 Componenten ergo grip; zijknijptang, combinatietang en punttang.



€ 78

316100

TORX T-SLEUTEL SET, 9DLG

Verstelbaar, T10-15-20-25-27-30-40-45-50



€ 69

423100

TANGENSET, 3DLG

Verstelbare moersleutel, waterpomptang, klemtang/snelspantang



€ 65

425000

WATERPOMPTANGENSET SPEEDY PLUS, 3 DLG

Nieuwste generatie waterpomptang met 30% groter bereik, betere grip door optimaal bekdesign. Verfijnde en snelle verstelling mogelijk dankzij nieuw spanveer ontwerp.

Inhoud (lengte/ max. bekopening): 180/42, 250/50, 300/70mm.



€ 115

421100

BORGRING TANGENSET, 4DLG

Recht open, recht dicht, haaks open, haaks dicht



€ 69,50

411000

ZAAG- EN SNIJSET, 3DLG

Incl 4 extra zaagbladen en 4 mes navullingen



€ 75

MOMENTSLEUTELS

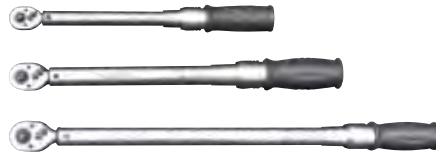

440140 1/4" Momentsleutel 4-22Nm, l=330mm € 99,00

440380 3/8" Momentsleutel 17-105Nm, l=440mm € 115,00

440120 1/2" Momentsleutel 60-340Nm, l=615mm € 118,00

414000

VIJLENSET, 5-DELIG

2 Componenten ergo grip, plat, vierkant, driehoek, half-rond, rond



€ 49,50

417000

CARROSSERIE UITDEUKSET, 7DLG

Incl 3 uitdeukhamers en 4 dolly's.



€ 199

415000

MEET EN PICK-UP GEREEDSCHAPSET, 7DLG

Voorzien van rvs liniaal (30cm), voelermaten set (20dlg), telescopische spiegel (57cm), pick-up tool met magnetische kop (tot 1,5kg), kraspen, gradenboog en schuifmaat.



€ 79,50

412000

HAMER EN PENDRIJVERSET, 8DLG

Hamer 500gr, kunststof hamer, beitel, centerpunter, pendrijvers 2-3-4-5mm



€ 69,50

428000

TANGENSET XL, 3DLG

Multifunctionele XL tangenset, bestaande uit Bougiekaptang (428010); 90° gebogen 4 punt fixering, fijn geribbelde bekken, ook geschikt voor bv. koperbuis, draadeind en kabels, lengte 280mm. Punttang lang (428020), fijn geribbelde bekken, lengte 280mm. Punttang lang 45° gebogen (428030), fijn geribbelde bekken, lengte 280mm.



€ 88

ACCESSOIRE MODULES LEEG



900900  360x145x43mm € 8,50



900902  435x 90x43mm € 7,50



900910  435x180x43mm € 9,50

126905 FOAM module (leeg) **S**
tbv 126000 (1/2" Doppenset E-torx)



360 x 145 mm

€ 16,-

127905 FOAM module (leeg) **S**
tbv 127000 (1/2" Doppenset
Veeltand-12kant/Ribe)

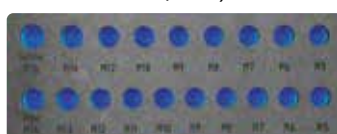

360 x 145 mm

€ 16,-

207905 FOAM module (leeg) **S**
tbv 207000 (Kniesleutelset)



360 x 145 mm

€ 16,-

422906 FOAM module (leeg) **S**
tbv 422100 (Tangenset)

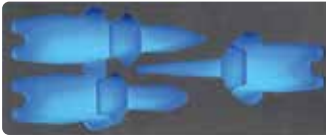

360 x 145 mm

€ 16,-

423906 FOAM module (leeg) **S**
tbv 423100 (Tangenset)



360 x 145 mm

€ 16,-

900912 Acc. module leeg FOAM, **S**
1gr + 2 kleine vakken



360 x 145 mm

€ 16,-

415905 FOAM module (leeg) **S**
tbv 415000 (meet+pick tools)



360 x 145 mm

€ 16,-

425905 FOAM module (leeg) **S**
tbv 425000 (tangenset)



360 x 145 mm

€ 16,-

428905 FOAM module (leeg) **S**
tbv 428000 (tangenset)



360 x 145 mm

€ 16,-

138905 FOAM module (leeg) **S**
tbv 138000 (bougie doppen)

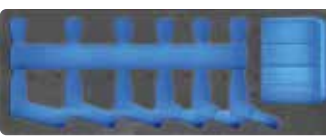

360 x 145 mm

€ 16,-



900914 **M**
Acc. module leeg FOAM,
3 vakken



435 x
90 mm

€ 12,-

122905 FOAM module (leeg) **M**
tbv 122000 (1/2" Doppenset Torx)

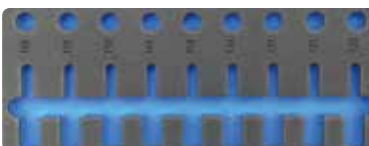

435 x
180 mm

€ 19,-

124905 FOAM module (leeg) **M**
tbv 124000 (1/2" Doppenset Inbus)

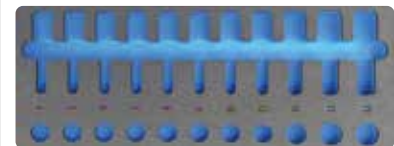

435 x
180 mm

€ 19,-

140905 FOAM module (leeg) **M**
tbv 140057 (1/4" Doppenset)

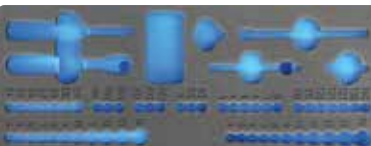

435 x
180 mm

€ 19,-

201906 FOAM module (leeg) **M**
tbv 201001 (Steekringsleutelset, 3dlg)

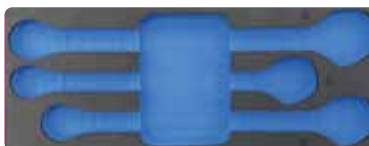

435 x
180 mm

€ 19,-

212905 FOAM module (leeg) **M**
tbv 212000 (Steekringratel sleutelset)



435 x
180 mm

€ 26,-

311905 FOAM module (leeg) **M**
tbv 311000 (Schroevendraaierset)



435 x
180 mm

€ 19,-

313905 FOAM module (leeg) **M**
tbv 313000 (Torx schroevendraaierset)



435 x
180 mm

€ 19,-

315906 FOAM module (leeg) **M**
tbv 315100 (T-sleutelset Inbus)



435 x
180 mm

€ 19,-

316906 FOAM module (leeg)
tbv 316100 (T-sleutelset Torx) M

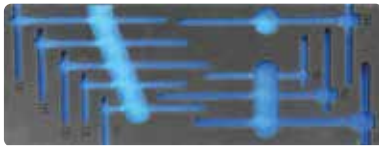

435 x
180 mm

€ 19,-

411905 FOAM module (leeg)
tbv 411000 (Set mes, schaar, zaag) M

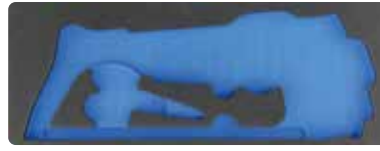

435 x
180 mm

€ 19,-

412905 FOAM module (leeg)
tbv 412000 (Hammer, pendrijvers) M

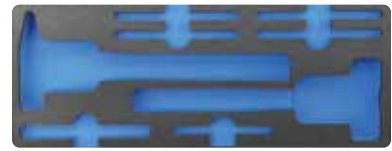

435 x
180 mm

€ 16,-

414905 FOAM module (leeg)
tbv 414000 (Vijlenset) M



435 x
180 mm

€ 16,-

421906 FOAM module (leeg)
tbv 421100 (Borgring tangenset) M



435 x
180 mm

€ 16,-

120905 FOAM module (leeg)
tbv 120025 (1/2" Doppenset) M

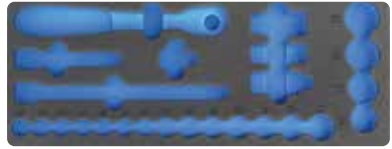

435 x
180 mm

€ 19,-

121905 FOAM module (leeg)
tbv 120018 (1/2" Doppenset) M

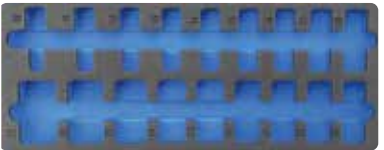

435 x
180 mm

€ 19,-

202905 FOAM module (leeg)
tbv 202000 (Steeksleutelset extra dun) M



435 x
180 mm

€ 19,-

900916
Acc. module leeg FOAM, 2 vakken M



435 x
180 mm

€ 16,-

900918
Acc. module leeg FOAM, 6 vakken M



435 x
180 mm

€ 16,-



203905 FOAM module (leeg)
tbv 203000 (Ringsleutelset gebogen) L



435 x
270 mm

€ 26,-

130905 FOAM module (leeg)
tbv 130071 (3/8" Doppenset) L

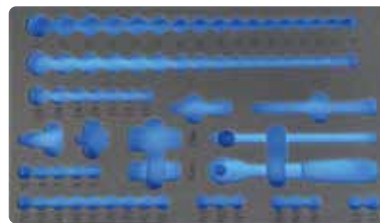

435 x
270 mm

€ 28,-

201905 FOAM module (leeg)
tbv 201000 (Steekringsleutelset) L

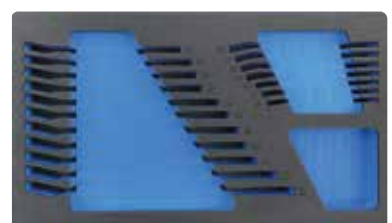

435 x
270 mm

€ 33,-

417905 FOAM module (leeg)
tbv 417000 (uitdeukset) L



435 x
270 mm

€ 19,-



HARDSCHALIGE LEGE MODULES



120900	Module leeg tbv 120025, 1/2" doppen set	€ 11,00
121900	Module leeg tbv 120018, 1/2" doppen set lang	€ 11,00
122900	Module leeg tbv 122000, 1/2" doppen torx	€ 11,00
124900	Module leeg tbv 124000, 1/2" doppen inbus	€ 11,00
126900	Module leeg tbv 126000, 1/2" doppen E-torx	€ 11,00
127900	Module leeg tbv 127000, 1/2" spline/ribe	€ 11,00
130900	Module leeg tbv 130071, 3/8" doppen set	€ 16,00
138900	Module leeg tbv 138000, bougie doppen set	€ 11,00
140900	Module leeg tbv 140057, 1/4" doppen set	€ 11,00
201900	Module leeg tbv 201000, steekringsleutels	€ 16,00
201901	Module leeg tbv 201001, steekringsleutels XL	€ 11,00
202900	Module leeg tbv 202000, steeksleutel set extra dun	€ 11,00
203900	Module leeg tbv 203000, ringsleutels	€ 11,00
207900	Module leeg tbv 207000, kniesleutel set	€ 11,00
212900	Module leeg tbv 212000, steekringratelsleutels L/R	€ 11,00
311900	Module leeg tbv 311000, schroevendraaiers	€ 11,00
313900	Module leeg tbv 313000, torx schroevendraaiers	€ 11,00
315901	Module leeg tbv 315100, inbus T-sleutels	€ 11,00
316901	Module leeg tbv 316100, torx T-Sleutels	€ 11,00
411900	Module leeg tbv 411000, set mes, schaar, zaag	€ 11,00
412900	Module leeg tbv 412000, hamers+pendrijvers	€ 11,00
414900	Module leeg tbv 414000, vijlenset	€ 11,00
415900	Module leeg tbv 415000, meet en pick up tools	€ 11,00
417900	Module leeg tbv 417000, carrosserie gereedsch.	€ 16,00
421901	Module leeg tbv 421100, tangen	€ 11,00
422901	Module leeg tbv 422100, tangen	€ 11,00
423901	Module leeg tbv 423100, tangen	€ 11,00
425900	Module leeg tbv 425000, tangen	€ 11,00
428900	Module leeg tbv 428000, tangen	€ 11,00

RATELS/ ROND MODEL

2 Componenten ergo grip (standaard in 501 koffers)



140001	1/4" Ratel/ rond model, 72T	€ 19,50
130001	3/8" Ratel/ rond model, 72T	€ 22,50
120001	1/2" Ratel/ rond model, 72T	€ 29,00

RATELS/ VLAK MODEL

2 Componenten ergo grip (standaard in modules)
Met snelontkoppeling-knop

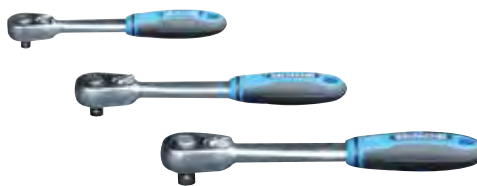

140000	1/4" Ratel/ vlak model, 72T	€ 19,50
130000	3/8" Ratel/ vlak model, 72T	€ 22,50
120000	1/2" Ratel/ vlak model, 72T	€ 29,00



501320

3/8" DOPPENRAIL 12-KANT, 15DLG

Inhoud: 8, 9, 10, 11, 12, 13, 14, 15, 16, 17, 18, 19, 20, 21, 22mm



€ 16,50

501322

3/8" DOPPENRAIL RESI TORX, 10DLG

Inhoud: T10H, T15H, T20H, T25H, T27H, T30H, T40H, T45H, T47H, T50H



€ 14,50

501323

3/8" DOPPENRAIL TORX LANG, 10DLG

Inhoud: T10, T15, T20, T25, T27, T30, T40, T45, T47, T50



€ 18,50

501324

3/8" DOPPENRAIL RESI TORX LANG, 10DLG

Inhoud: T10H, T15H, T20H, T25H, T27H, T30H, T40H, T45H, T47H, T50H



€ 19

501326

3/8" DOPPENRAIL INBUS LANG, 9DLG

Inhoud: H3, H4, H5, H6, H7, H8, H9, H10, H12



€ 19

501328

3/8" DOPPENRAIL VEELTAND-SPLINE LANG, 8DLG

Inhoud: M5, M6, M7, M8, M9, M10, M11, M12



€ 19

501329

3/8" DOPPENRAIL RIBE LANG, 7DLG

Inhoud: RM4, RM5, RM6, RM7, RM8, RM9, RM10



€ 15,50

501210

1/2" DOPPENSET TORX/ INBUS/ VEELTAND/ RIBE, 40DLG

Torx: T20, T25, T27, T30, T40, T45, T50, T55, T60, T70

Inbus: H5, H6, H7, H8, H9, H10, H11, H12, H14, H17, H19

Veeltand: M5, M6, M7, M8, M9, M10, M11, M12, M14, M16

Ribe: RM5, RM6, RM7, RM8, RM9, RM10, RM12, RM13, RM14
(Lengte= 55mm)



FOAM
INLAY

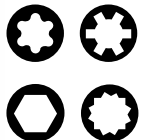

€ 79,50

501060

ADAPTER SET, 6DLG

Inw Uitw
1/4" - 3/8"
3/8" - 1/2"
1/2" - 3/4"

3/8" - 1/4"
1/2" - 3/8"
3/4" - 1/2"



€ 18

501212

1/2" DOPPENSET TORX, 32DLG

1/2"



Inhoud:

Lengte 55mm: T20-T25-T27-T30-T40-T45-T50-T55-T60-T70

Lengte 100mm: T20-T25-T27-T30-T40-T45-T50-T55-T60-T70

Lengte 140mm: T40-T45-T50-T55-T60-T70

Lengte 200mm: T40-T45-T50-T55-T60-T70



FOAM
INLAY

€ 89

501214

1/2" DOPPENSET VEELTAND-SPLINE, 30DLG

1/2"



Inhoud:

Lengte 55mm: M5-M6-M7-M8-M9-M10-M11-M12-M14-M16

Lengte 100mm: M5-M6-M7-M8-M9-M10-M11-M12-M14

Lengte 140mm: M5-M6-M8-M9-M10-M12-M14

Lengte 200mm: M8-M10-M12-M14



FOAM
INLAY

€ 89

501216

1/2" DOPPENSET INBUS, 32DLG

1/2"



Inhoud:

Lengte 55mm: H4-H5-H6-H7-H8-H9-H10-H12-H14-H17-H19

Lengte 100mm: H5-H6-H7-H8-H9-H10-H11-H12

Lengte 140mm: H5-H6-H7-H8-H10-H12-H14

Lengte 200mm: H5-H6-H7-H8-H10-H12



FOAM
INLAY

€ 89

501218

1/2" DOPPENSET RIBE, 32DLG

1/2"



Inhoud:

Lengte 55mm: RM5 t/m RM10-RM12-RM13-RM14

Lengte 100mm: RM5 t/m RM10-RM12-RM13-RM14

Lengte 140mm: RM8-RM9-RM10-RM10.3-RM12-RM13-RM14

Lengte 200mm: RM8-RM9-RM10-RM10.3-RM12-RM13-RM14



FOAM
INLAY

€ 89

501402

1/4" DOPPENSET, 59DLG

1/4"

1/4" Ratel, korte doppen 4-4,5-5-5,5 t/m 14mm, lange doppen 6 t/m 13m, inbus H3 t/m H8, PH 1-2-3, PZ 1-2-3, Plat 4-5,5-7Torx T10-15-20-25-27-30-40, veeltand/Spline M4- -6-8-10 verlengstukken 50-100-150mm, L stuk, wringijzer, kniestuk



€ 45

501302

3/8" DOPPENSET, 61DLG

3/8"

3/8" Ratel, korte doppen 6 t/m 22-24mm, lange doppen 8 t/m 15-17-19mm, bougiedop 16-21, adaptor van 1/2" naar 3/8" (met gat tbv verlengstuk, adaptor 3/8" - 5/16", inbus H3 t/m H8-H10, PH 1-2-3, PZ 1-2-3, plat 5,5-7-8, Torx T15-20-25-27-30-40-45-50-55, verlengstukken 75-250mm, kniestuk



€ 68

501204

1/2" DOPPENSET, 26DLG

1/2"

1/2" Ratel, korte doppen 8 t/m 22-24-27-30-32mm, bougiedop 16-21mm, verlengstukken 125-250mm, kniestuk



€ 85

501202

1/4" + 1/2" DOPPENSET, 108DLG

1/4"

1/2"

1/4" Ratel, korte doppen 4-4,5-5-5,5 t/m 14mm, E-torx E4-E5-E6-E7-E8, lange doppen 6 t/m 13m, inbus H3 t/m H6, PH1-2 PZ1-2, plat SL4-5,5-6,5, Torx T8-T10-T15-T20-T25-T27-T30 verlengstukken 50-100mm, wringijzer, kniestuk, 1/4" schroevendraaier bithouder

1/2" Ratel, korte doppen 10 t/m 22-24-27-30-32mm, E-torx E10-E11-E12-E14-E16-E20-E24, lange doppen 14-15-17-19-22mm, bougiedop 16-21mm, verlengstuk 125-250mm kniestuk, adaptor 3/8" naar 1/2" (met gat icm verlengstuk te gebruiken), bithouder tbv 8mm bits, bits 8mm PH3-4, PZ3-4, plat SL8-10-12, inbus H7-H8-H10-H12-H14, Torx T40-T45-T50-T55-T60



€ 115

520505

MOBIELE GEREEDSCHAPSKOFFER, GEVULD IN FOAM

Heavy Duty koffer met 4 (uitneembare) FOAM modules gereedschap, 127dlg. Voorzien van stootvaste transportwieltjes en uitschuifbare handgreep.
Gesloten koffer is lucht- en waterdicht! Afmeting 580x 370x 250mm, Gewicht 15,6kg.

140057 Doppenset 1/4", 57pcs

Ratel, korte + lange doppen 4-14mm, E-torx 4-5-6-7-8-10-11mm, T10-15-20-25-27-30-40, H3-4-5-6-7-8mm, plat 4-5,5-6,5mm, PH1-2-3, PZ1-2-3, etc.

120025 Doppenset 1/2", 25pcs

Ratel, korte doppen: 10-11-12-13-14-15-16-17-18-19-20-21-22-23-24-27-30-32mm, bougiedoppen: 16-21mm, E-torx 10-11-12-14-16-18-20mm, etc.

201000 Steekringsleutelset, 18pcs

6-7-8-9-10-11-12-13-14-15-16-17-18-19-20-21-22-24mm

311000 Schroevendraaierset, 8pcs

Plat 3-4-5,5-6,5mm, PH 0-1-2-3

412020 Hamer 500g , **422110** Punttang, **422130** Combinatietang, **422140** Zijkniptang, **411020** Afbreekmes , **411030** Schaar, **423110** Waterpomptang, **990002** IJzerzaag klein, **990004**, Inbussleutelset, 9dlg, **990006** Rolmaat 5m, LED lamp



**FOAM
INLAY**









520585 Koffer leeg € 179

€ 598







ONDERDELEN 1/4"

1/4"

140040	1/4" dop 4mm	€ 4,90		144130	1/4" dop H3	€ 4,90	
140045	1/4" dop 4,5mm	€ 4,90		144140	1/4" dop H4	€ 4,90	
140050	1/4" dop 5mm	€ 4,90		144150	1/4" dop H5	€ 4,90	
140060	1/4" dop 6mm	€ 4,90		144160	1/4" dop H6	€ 4,90	
140070	1/4" dop 7mm	€ 4,90		144170	1/4" dop H7	€ 4,90	
140080	1/4" dop 8mm	€ 4,90		144180	1/4" dop H8	€ 4,90	
140090	1/4" dop 9mm	€ 4,90		144210	1/4" dop PH1	€ 4,90	
140100	1/4" dop 10mm	€ 4,90		144220	1/4" dop PH2	€ 4,90	
140110	1/4" dop 11mm	€ 4,90		144230	1/4" dop PH3	€ 4,90	
140120	1/4" dop 12mm	€ 4,90		144310	1/4" dop PZ1	€ 4,90	
140130	1/4" dop 13mm	€ 5,00		144320	1/4" dop PZ2	€ 4,90	
140140	1/4" dop 14mm	€ 5,50		144330	1/4" dop PZ3	€ 4,90	
141040	1/4" dop 4mm, lang	€ 5,60		144440	1/4" dop plat 4mm	€ 4,90	
141050	1/4" dop 5mm, lang	€ 5,60		144455	1/4" dop plat 5,5mm	€ 4,90	
141060	1/4" dop 6mm, lang	€ 5,60		144460	1/4" dop plat 6,5mm	€ 4,90	
141070	1/4" dop 7mm, lang	€ 5,60		146040	1/4" dop E4	€ 5,60	
141080	1/4" dop 8mm, lang	€ 5,60		146050	1/4" dop E5	€ 5,60	
141090	1/4" dop 9mm, lang	€ 5,60		146060	1/4" dop E6	€ 5,60	
141100	1/4" dop 10mm, lang	€ 5,60		146070	1/4" dop E7	€ 5,60	
141110	1/4" dop 11mm, lang	€ 5,60		146080	1/4" dop E8	€ 5,60	
141120	1/4" dop 12mm, lang	€ 5,60		146100	1/4" dop E10	€ 5,60	
141130	1/4" dop 13mm, lang	€ 5,90		146110	1/4" dop E11	€ 5,60	
141140	1/4" dop 14mm, lang	€ 6,30		149050	1/4" verlengstuk 50mm	€ 5,00	
142010	1/4" dop T10	€ 4,90		149150	1/4" verlengstuk 150mm	€ 6,90	
142015	1/4" dop T15	€ 4,90		149520	1/4" kniestuk	€ 6,90	
142020	1/4" dop T20	€ 4,90		149540	1/4" schroevendraaier	€ 7,50	
142025	1/4" dop T25	€ 4,90		149550	1/4" wringijzer	€ 7,50	
142027	1/4" dop T27	€ 4,90					
142030	1/4" dop T30	€ 4,90					
142040	1/4" dop T40	€ 4,90					

ONDERDELEN 3/8"



3/8"

130060	3/8" dop 6mm	€ 5,80		132010	3/8" dop T10	€ 5,90	
130070	3/8" dop 7mm	€ 5,80		132015	3/8" dop T15	€ 5,90	
130080	3/8" dop 8mm	€ 5,80		132020	3/8" dop T20	€ 5,90	
130090	3/8" dop 9mm	€ 5,80		132025	3/8" dop T25	€ 5,90	
130100	3/8" dop 10mm	€ 5,80		132027	3/8" dop T27	€ 5,90	
130110	3/8" dop 11mm	€ 5,80		132030	3/8" dop T30	€ 5,90	
130120	3/8" dop 12mm	€ 5,80		132040	3/8" dop T40	€ 5,90	
130130	3/8" dop 13mm	€ 5,80		132045	3/8" dop T45	€ 6,50	
130140	3/8" dop 14mm	€ 5,80		132050	3/8" dop T50	€ 6,50	
130150	3/8" dop 15mm	€ 5,80		132055	3/8" dop T55	€ 6,80	
130160	3/8" dop 16mm	€ 5,80		134030	3/8" dop H3	€ 5,90	
130170	3/8" dop 17mm	€ 6,00		134040	3/8" dop H4	€ 5,90	
130180	3/8" dop 18mm	€ 6,00		134050	3/8" dop H5	€ 5,90	
130190	3/8" dop 19mm	€ 6,00		134060	3/8" dop H6	€ 5,90	
130200	3/8" dop 20mm	€ 6,50		134070	3/8" dop H7	€ 6,30	
130210	3/8" dop 21mm	€ 6,50		134080	3/8" dop H8	€ 6,30	
130220	3/8" dop 22mm	€ 6,50		134100	3/8" dop H10	€ 6,60	
131060	3/8" dop 6mm, lang	€ 7,00		134210	3/8" dop PH1	€ 6,00	
131070	3/8" dop 7mm, lang	€ 7,00		134220	3/8" dop PH2	€ 6,00	
131080	3/8" dop 8mm, lang	€ 7,00		134230	3/8" dop PH3	€ 6,00	
131090	3/8" dop 9mm, lang	€ 7,00		134310	3/8" dop PZ1	€ 6,00	
131100	3/8" dop 10mm, lang	€ 7,00		134320	3/8" dop PZ2	€ 6,00	
131110	3/8" dop 11mm, lang	€ 7,00		134330	3/8" dop PZ3	€ 6,00	
131120	3/8" dop 12mm, lang	€ 7,00		134410	3/8" dop Plat 5,5mm	€ 6,00	
131130	3/8" dop 13mm, lang	€ 7,00		134420	3/8" dop Plat 6,5mm	€ 6,00	
131140	3/8" dop 14mm, lang	€ 7,00		134430	3/8" dop Plat 8mm	€ 6,00	
131150	3/8" dop 15mm, lang	€ 7,30		136010	3/8" dop E10	€ 5,70	
131160	3/8" dop 16mm, lang	€ 7,30		136011	3/8" dop E11	€ 5,70	
131170	3/8" dop 17mm, lang	€ 7,40		136012	3/8" dop E12	€ 5,70	
131180	3/8" dop 18mm, lang	€ 7,60		136014	3/8" dop E14	€ 5,70	
131190	3/8" dop 19mm, lang	€ 7,60					
131200	3/8" dop 20mm, lang	€ 8,40					
131210	3/8" dop 21mm, lang	€ 8,40					
131220	3/8" dop 22mm, lang	€ 8,90					

>>>



>>> ONDERDELEN 3/8"

3/8"

136016	3/8" dop E16		€ 6,60	139334	3/8" Bougiedop 14mm, 12 kant		€ 7,50
136018	3/8" dop E18		€ 6,90	139336	3/8" Bougiedop 16mm, 12 kant		€ 7,50
136020	3/8" dop E20		€ 7,60	139338	3/8" Bougiedop 18mm, 12 kant		€ 7,90
				139341	3/8" Bougiedop 21mm, 12 kant		€ 7,90
139075	3/8" verlengstuk 75mm		€ 6,60	139358	3/8" Bougiedop 8mm, XL met kniegewricht		€ 16,50
139150	3/8" verlengstuk 150mm		€ 8,50	139359	3/8" Bougiedop 9mm, XL met kniegewricht		€ 16,50
139250	3/8" Verlengstuk 250mm		€ 10,80	139360	3/8" Bougiedop 10mm, XL met kniegewricht		€ 16,50
139316	3/8" bougiedop 16mm		€ 7,20	139362	3/8" Bougiedop 12mm, XL met kniegewricht		€ 16,50
139321	3/8" bougiedop 21mm		€ 8,40	139364	3/8" Bougiedop 14mm, XL met kniegewricht		€ 16,50
139515	3/8"-1/2" Adaptor		€ 7,00	139366	3/8" Bougiedop 16mm, XL met kniegewricht		€ 16,50
139520	3/8" kniestuk		€ 8,00				
139550	3/8" Wringijzer		€ 9,80				



ONDERDELEN 1/2"

1/2"

120080	1/2" dop 8mm		€ 5,20	122120	1/2" dop torx T20, 100mm		€ 9,00
120090	1/2" dop 9mm		€ 5,20	122125	1/2" dop torx T25, 100mm		€ 9,00
120100	1/2" dop 10mm		€ 5,20	122127	1/2" dop torx T27, 100mm		€ 9,00
120110	1/2" dop 11mm		€ 5,20	122130	1/2" dop torx T30, 100mm		€ 9,00
120120	1/2" dop 12mm		€ 5,20	122140	1/2" dop torx T40, 100mm		€ 9,00
120130	1/2" dop 13mm		€ 5,20	122145	1/2" dop torx T45, 100mm		€ 9,00
120140	1/2" dop 14mm		€ 5,20	122150	1/2" dop torx T50, 100mm		€ 9,00
120150	1/2" dop 15mm		€ 5,20	122155	1/2" dop torx T55, 100mm		€ 9,00
120160	1/2" dop 16mm		€ 5,20	122160	1/2" dop torx T60, 100mm		€ 9,00
120170	1/2" dop 17mm		€ 5,80	122170	1/2" dop torx T70, 100mm		€ 9,60
120180	1/2" dop 18mm		€ 5,80				
120190	1/2" dop 19mm		€ 5,80	122240	1/2" dop torx T40, 140mm		€ 10,40
120200	1/2" dop 20mm		€ 6,60	122245	1/2" dop torx T45, 140mm		€ 10,40
120210	1/2" dop 21mm		€ 6,60	122250	1/2" dop torx T50, 140mm		€ 10,40
120220	1/2" dop 22mm		€ 6,60	122255	1/2" dop torx T55, 140mm		€ 10,40
120230	1/2" dop 23mm		€ 6,60	122260	1/2" dop torx T60, 140mm		€ 11,00
120240	1/2" dop 24mm		€ 6,60	122270	1/2" dop torx T70, 140mm		€ 11,80
120270	1/2" dop 27mm		€ 8,20				
120300	1/2" dop 30mm		€ 10,90	122340	1/2" dop torx T40, 200mm		€ 11,40
120320	1/2" dop 32mm		€ 10,90	122345	1/2" dop torx T45, 200mm		€ 11,40
				122350	1/2" dop torx T50, 200mm		€ 11,40
121100	1/2" dop 10mm, lang		€ 6,90	122355	1/2" dop torx T55, 200mm		€ 11,40
121110	1/2" dop 11mm, lang		€ 6,90	122360	1/2" dop torx T60, 200mm		€ 12,00
121120	1/2" dop 12mm, lang		€ 6,90	122370	1/2" dop torx T70, 200mm		€ 13,80
121130	1/2" dop 13mm, lang		€ 6,90				
121140	1/2" dop 14mm, lang		€ 6,90	124040	1/2" dop inbus H4		€ 7,40
121150	1/2" dop 15mm, lang		€ 6,90	124050	1/2" dop inbus H5		€ 7,40
121160	1/2" dop 16mm, lang		€ 6,90	124060	1/2" dop inbus H6		€ 7,40
121170	1/2" dop 17mm, lang		€ 7,20	124070	1/2" dop inbus H7		€ 7,40
121180	1/2" dop 18mm, lang		€ 7,20	124080	1/2" dop inbus H8		€ 7,40
121190	1/2" dop 19mm, lang		€ 7,20	124090	1/2" dop inbus H9		€ 7,40
121200	1/2" dop 20mm, lang		€ 8,80	124100	1/2" dop inbus H10		€ 7,40
121210	1/2" dop 21mm, lang		€ 8,80	124110	1/2" dop inbus H11		€ 7,40
121220	1/2" dop 22mm, lang		€ 8,80	124120	1/2" dop inbus H12		€ 7,40
121230	1/2" dop 23mm, lang		€ 9,90	124140	1/2" dop inbus H14		€ 8,40
121240	1/2" dop 24mm, lang		€ 9,90	124170	1/2" dop inbus H17		€ 8,40
121270	1/2" dop 27mm, lang		€ 11,40	124190	1/2" dop inbus H19		€ 8,90
121300	1/2" dop 30mm, lang		€ 13,20				
121320	1/2" dop 32mm, lang		€ 13,80	124240	1/2" dop inbus H4, 100mm		€ 8,40
				124250	1/2" dop inbus H5, 100mm		€ 8,40
122020	1/2" dop torx T20		€ 7,20	124260	1/2" dop inbus H6, 100mm		€ 8,40
122025	1/2" dop torx T25		€ 7,20	124270	1/2" dop inbus H7, 100mm		€ 8,40
122027	1/2" dop torx T27		€ 7,20	124280	1/2" dop inbus H8, 100mm		€ 8,40
122030	1/2" dop torx T30		€ 7,20	124290	1/2" dop inbus H9, 100mm		€ 8,40
122040	1/2" dop torx T40		€ 7,20	124300	1/2" dop inbus H10, 100mm		€ 8,40
122045	1/2" dop torx T45		€ 7,20	124310	1/2" dop inbus H11, 100mm		€ 9,00
122050	1/2" dop torx T50		€ 7,20	124320	1/2" dop inbus H12, 100mm		€ 9,00
122055	1/2" dop torx T55		€ 7,20	124340	1/2" dop inbus H14, 100mm		€ 9,80
122060	1/2" dop torx T60		€ 7,20				
122070	1/2" dop torx T70		€ 7,60				

>>> ONDERDELEN 1/2"

1/2"

124370	1/2" dop inbus H17, 100mm	€ 11,00	
124390	1/2" dop inbus H19, 100mm	€ 12,50	
124450	1/2" dop inbus H5, 140mm	€ 10,50	
124460	1/2" dop inbus H6, 140mm	€ 10,50	
124470	1/2" dop inbus H7, 140mm	€ 10,50	
124480	1/2" dop inbus H8, 140mm	€ 10,50	
124500	1/2" dop inbus H10, 140mm	€ 10,50	
124520	1/2" dop inbus H12, 140mm	€ 11,50	
124540	1/2" dop inbus H14, 140mm	€ 12,00	
124650	1/2" dop inbus H5, 200mm	€ 11,50	
124660	1/2" dop inbus H6, 200mm	€ 11,50	
124670	1/2" dop inbus H7, 200mm	€ 11,50	
124680	1/2" dop inbus H8, 200mm	€ 11,50	
124700	1/2" dop inbus H10, 200mm	€ 12,00	
124720	1/2" dop inbus H12, 200mm	€ 13,80	
126010	1/2" dop E-torx 10	€ 6,40	
126011	1/2" dop E-torx 11	€ 6,40	
126012	1/2" dop E-torx 12	€ 6,40	
126014	1/2" dop E-torx 14	€ 6,40	
126016	1/2" dop E-torx 16	€ 6,40	
126018	1/2" dop E-torx 18	€ 6,40	
126020	1/2" dop E-torx 20	€ 6,40	
126022	1/2" dop E-torx 22	€ 6,40	
126024	1/2" dop E-torx 24	€ 6,90	
126110	1/2" dop E-torx 10, 100mm	€ 9,80	
126111	1/2" dop E-torx 11, 100mm	€ 9,80	
126112	1/2" dop E-torx 12, 100mm	€ 9,80	
126114	1/2" dop E-torx 14, 100mm	€ 9,80	
126116	1/2" dop E-torx 16, 100mm	€ 9,80	
126118	1/2" dop E-torx 18, 100mm	€ 9,80	
126120	1/2" dop E-torx 20, 100mm	€ 10,50	
126122	1/2" dop E-torx 22, 100mm	€ 10,50	
126124	1/2" dop E-torx 24, 100mm	€ 11,60	
127005	1/2" dop Veeltand-12kant M5	€ 6,90	
127006	1/2" dop Veeltand-12kant M6	€ 6,90	
127007	1/2" dop Veeltand-12kant M7	€ 6,90	
127008	1/2" dop Veeltand-12kant M8	€ 6,90	
127009	1/2" dop Veeltand-12kant M9	€ 6,90	
127010	1/2" dop Veeltand-12kant M10	€ 6,90	
127011	1/2" dop Veeltand-12kant M11	€ 7,40	
127012	1/2" dop Veeltand-12kant M12	€ 7,40	
127014	1/2" dop Veeltand-12kant M14	€ 9,00	
127016	1/2" dop Veeltand-12kant M16	€ 11,50	
127018	1/2" dop Veeltand-12kant M18	€ 11,90	
127105	1/2" dop Veeltand-12kant M5, 100mm	€ 8,60	
127106	1/2" dop Veeltand-12kant M6, 100mm	€ 8,60	
127107	1/2" dop Veeltand-12kant M7, 100mm	€ 8,60	
127108	1/2" dop Veeltand-12kant M8, 100mm	€ 8,60	
127109	1/2" dop Veeltand-12kant M9, 100mm	€ 9,20	
127110	1/2" dop Veeltand-12kant M10, 100mm	€ 9,20	
127111	1/2" dop Veeltand-12kant M11, 100mm	€ 9,20	
127112	1/2" dop Veeltand-12kant M12, 100mm	€ 9,20	
127114	1/2" dop Veeltand-12kant M14, 100mm	€ 9,50	
127205	1/2" dop Veeltand-12kant M5, 140mm	€ 10,50	
127206	1/2" dop Veeltand-12kant M6, 140mm	€ 10,50	
127208	1/2" dop Veeltand-12kant M8, 140mm	€ 10,50	
127209	1/2" dop Veeltand-12kant M9, 140mm	€ 10,50	
127210	1/2" dop Veeltand-12kant M10, 140mm	€ 10,50	
127212	1/2" dop Veeltand-12kant M12, 140mm	€ 11,50	
127214	1/2" dop Veeltand-12kant M14, 140mm	€ 11,80	
127308	1/2" dop Veeltand-12kant M8, 200mm	€ 11,60	
127310	1/2" dop Veeltand-12kant M10, 200mm	€ 11,60	
127312	1/2" dop Veeltand-12kant M12, 200mm	€ 12,50	
127314	1/2" dop Veeltand-12kant M14, 200mm	€ 13,80	
128005	1/2" dop Ribe M5	€ 7,00	
128006	1/2" dop Ribe M6	€ 7,00	
128007	1/2" dop Ribe M7	€ 7,00	
128008	1/2" dop Ribe M8	€ 7,00	
128009	1/2" dop Ribe M9	€ 7,00	
128010	1/2" dop Ribe M10	€ 7,00	
128011	1/2" dop Ribe M11	€ 7,70	
128012	1/2" dop Ribe M12	€ 7,70	
128013	1/2" dop Ribe M13	€ 8,90	
128014	1/2" dop Ribe M14	€ 8,90	
128105	1/2" dop Ribe M5, 100mm	€ 8,60	
128106	1/2" dop Ribe M6, 100mm	€ 8,60	
128107	1/2" dop Ribe M7, 100mm	€ 8,60	
128108	1/2" dop Ribe M8, 100mm	€ 8,60	
128109	1/2" dop Ribe M9, 100mm	€ 9,00	
128110	1/2" dop Ribe M10, 100mm	€ 9,00	
128112	1/2" dop Ribe M12, 100mm	€ 9,20	
128113	1/2" dop Ribe M13, 100mm	€ 9,40	
128114	1/2" dop Ribe M14, 100mm	€ 9,40	
128208	1/2" dop Ribe M8, 140mm	€ 10,50	
128209	1/2" dop Ribe M9, 140mm	€ 10,50	
128210	1/2" dop Ribe M10, 140mm	€ 10,50	
128211	1/2" dop Ribe M11, 140mm	€ 11,50	
128212	1/2" dop Ribe M12, 140mm	€ 11,50	
128213	1/2" dop Ribe M13, 140mm	€ 11,80	
128214	1/2" dop Ribe M14, 140mm	€ 11,80	
128308	1/2" dop Ribe M8, 200mm	€ 11,50	
128309	1/2" dop Ribe M9, 200mm	€ 11,50	
128310	1/2" dop Ribe M10, 200mm	€ 11,50	
128311	1/2" dop Ribe M11, 200mm	€ 12,00	
128312	1/2" dop Ribe M12, 200mm	€ 12,00	
128313	1/2" dop Ribe M13, 200mm	€ 13,60	
128314	1/2" dop Ribe M14, 200mm	€ 13,60	
129125	1/2" verlengstuk 125mm	€ 11,00	
129250	1/2" verlengstuk 250mm	€ 16,50	
129316	1/2" bougiedop 16mm	€ 6,50	
129321	1/2" bougiedop 21mm	€ 7,80	
129510	1/2"-3/8" Adaptor (met gat)	€ 7,00	
129520	1/2" kniestuk	€ 15,00	



SLEUTELS



201060	Steekringsleutel 6mm	€ 6,50
201070	Steekringsleutel 7mm	€ 6,50
201080	Steekringsleutel 8mm	€ 6,50
201090	Steekringsleutel 9mm	€ 6,50
201100	Steekringsleutel 10mm	€ 7,00
201110	Steekringsleutel 11mm	€ 7,40
201120	Steekringsleutel 12mm	€ 7,80
201130	Steekringsleutel 13mm	€ 8,40
201140	Steekringsleutel 14mm	€ 9,20
201150	Steekringsleutel 15mm	€ 10,20
201160	Steekringsleutel 16mm	€ 10,20
201170	Steekringsleutel 17mm	€ 11,20
201180	Steekringsleutel 18mm	€ 12,00
201190	Steekringsleutel 19mm	€ 13,00
201200	Steekringsleutel 20mm	€ 14,00
201210	Steekringsleutel 21mm	€ 16,70
201220	Steekringsleutel 22mm	€ 17,90
201240	Steekringsleutel 24mm	€ 20,50
201270	Steekringsleutel 27mm	€ 27,50
201300	Steekringsleutel 30mm	€ 32,50
201320	Steekringsleutel 32mm	€ 36,50



203060	Ringsleutel gebogen 6x7mm	€ 9,80
203080	Ringsleutel gebogen 8x9mm	€ 10,80
203100	Ringsleutel gebogen 10x11mm	€ 12,20
203120	Ringsleutel gebogen 12x13mm	€ 13,80
203140	Ringsleutel gebogen 14x15mm	€ 16,00
203160	Ringsleutel gebogen 16x17mm	€ 18,00
203180	Ringsleutel gebogen 18x19mm	€ 19,50
203200	Ringsleutel gebogen 20x22mm	€ 22,40
203240	Ringsleutel gebogen 24x27mm	€ 28,00
203300	Ringsleutel gebogen 30x32mm	€ 37,00



207060	Kniesleutel 6x7mm	€ 11,00
207080	Kniesleutel 8x9mm	€ 11,00
207100	Kniesleutel 10x11mm	€ 12,20
207120	Kniesleutel 12x13mm	€ 12,40
207140	Kniesleutel 14x15mm	€ 14,50
207160	Kniesleutel 16x17mm	€ 17,50
207180	Kniesleutel 18x19mm	€ 19,50
207200	Kniesleutel 20x22mm	€ 28,00



212080	Steekringratelsleutel L/R, 8mm	€ 18,00
212090	Steekringratelsleutel L/R, 9mm	€ 18,00
212100	Steekringratelsleutel L/R, 10mm	€ 18,00
212110	Steekringratelsleutel L/R, 11mm	€ 19,50
212120	Steekringratelsleutel L/R, 12mm	€ 19,50
212130	Steekringratelsleutel L/R, 13mm	€ 21,00
212140	Steekringratelsleutel L/R, 14mm	€ 22,50
212150	Steekringratelsleutel L/R, 15mm	€ 23,00
212160	Steekringratelsleutel L/R, 16mm	€ 23,50
212170	Steekringratelsleutel L/R, 17mm	€ 26,50
212180	Steekringratelsleutel L/R, 18mm	€ 28,00
212190	Steekringratelsleutel L/R, 19mm	€ 29,50



SCHROEVENDRAAIERS EN T-SLEUTELS



311010	Schroevendraaier plat 3x 75mm	€ 6,60
311020	Schroevendraaier plat 4x 100mm	€ 6,60
311030	Schroevendraaier plat 5,5x 125mm	€ 6,90
311040	Schroevendraaier plat 6,5x 150mm	€ 7,90



311110	Schroevendraaier PH0x 60mm	€ 5,80
311120	Schroevendraaier PH1x 80mm	€ 6,50
311130	Schroevendraaier PH2x 100mm	€ 7,20
311140	Schroevendraaier PH3x 150mm	€ 9,20



313008	Torx schroevendraaier T8	€ 5,90
313010	Torx schroevendraaier T10	€ 6,40
313015	Torx schroevendraaier T15	€ 6,40
313020	Torx schroevendraaier T20	€ 6,80

313025	Torx schroevendraaier T25	€ 6,80
313027	Torx schroevendraaier T27	€ 7,30
313030	Torx schroevendraaier T30	€ 8,50
313040	Torx schroevendraaier T40	€ 9,40

315120	Inbus T-Sleutel 2mm	€ 8,50
315125	Inbus T-Sleutel 2,5mm	€ 8,50
315130	Inbus T-Sleutel 3mm	€ 8,50
315140	Inbus T-Sleutel 4mm	€ 9,40
315150	Inbus T-Sleutel 5mm	€ 9,40
315160	Inbus T-Sleutel 6mm	€ 12,00
315170	Inbus T-Sleutel 7mm	€ 12,60
315180	Inbus T-Sleutel 8mm	€ 13,40

316110	Torx T-Sleutel T10	€ 8,50
316115	Torx T-Sleutel T15	€ 8,50
316120	Torx T-Sleutel T20	€ 8,50
316125	Torx T-Sleutel T25	€ 9,30
316127	Torx T-Sleutel T27	€ 9,30
316130	Torx T-Sleutel T30	€ 9,30
316140	Torx T-Sleutel T40	€ 12,00
316145	Torx T-Sleutel T45	€ 12,00
316150	Torx T-Sleutel T50	€ 13,40

422110 PUNTTANG

Punttang halfronnd, fijn geribbelde bekken met gehard snijgedeelte. Lengte 200mm. Specificatie volgens DIN ISO 5745.



€ 29

422120 PUNTTANG GEBOGEN

Punttang, 40° gebogen, fijn geribbelde bekken met gehard snijgedeelte. Lengte 200mm. Specificatie volgens DIN ISO 5745.



€ 29,50

422130 COMBINATIETANG

Geharde snijbekken en gekarteld gedeelte voor maximale grip op ronde delen. Lengte 200mm. Specificatie volgens DIN ISO 5746.



€ 26

422140 ZIJKNIPTANG

Geschikt voor zowel zachte als piano draad, geharde snijbekken. Lengte 180mm. Specificatie volgens DIN ISO 5749.



€ 29,90

423110 WATERPOMPTANG

Zelfklemmend op buizen en moeren voor veilig en kracht besparend gebruik. Lengte 240mm. Specificatie volgens DIN ISO 8976.



€ 24

423120 GRIPTANG

Lengte 235mm



€ 29

423030 VERSTELBARE MOERSLEUTEL 200MM

Lengte 200mm, max. bekopening 30mm



€ 29

WATERPOMPTANG SPEEDY PLUS

Nieuwste generatie waterpomptang met 30% groter bereik, betere grip door optimaal bekdesign. Verfijnde en snelle verstelling mogelijk dankzij nieuw spanveer ontwerp.



425010 Lengte/ max. bekopening: 180/42mm € 36,00

425020 Lengte/ max. bekopening: 250/50mm € 38,00

425030 Lengte/ max. bekopening: 300/70mm € 49,00

428010 BOUGIEKAPTANG 280MM

Bougiekaptang, 90° gebogen, 4 punt fixering, fijn geribbelde bekken. Lengte 280mm. Specificatie volgens DIN ISO 5745



€ 35

428020 PUNTTANG, EXTRA LANG, 280MM

Punttang extra lang, fijn geribbelde bekken, lengte 280mm. Specificatie volgens DIN ISO 5745



€ 29,50

428030 PUNTTANG GEBOGEN, EXTRA LANG, 280MM

Punttang lang, 45° gebogen, fijn geribbelde bekken, lengte 280mm. Specificatie volgens DIN ISO 5745



€ 32

421110
BORGRING TANG

Borgring tang tbv binnenring, recht



€ 17,50

421120
BORGRING TANG

Borgring tang tbv buitenring, recht



€ 21

421130
BORGRING TANG

Borgring tang tbv binnenring, haaks



€ 17,50

421140
BORGRING TANG

Borgring tang tbv buitenring, haaks



€ 21,50

411010
IJZERZAAG 24T



€ 39

411020
AFBREEKMES MET 4 MESJES



€ 18

411030
SCHAAR



€ 29

412010
HAMER KUNSTSTOF KOP, 35MM



412012 Losse kop €8

€ 29,50

412020
HAMER 500GR



€ 18

412030
BEITEL



€ 9,50

412040
CENTER PUNTER

4x120mm



€ 6

PENDRIJVERS



- 412042 2x150mm
- 412043 3x150mm
- 412044 4x150mm
- 412045 5x150mm

€ 6

VIJLEN



- 414010 Plat
- 414020 Half rond
- 414030 Rond
- 414040 Vierkant
- 414050 Driehoek

€ 12,50

411012
ZAAGBLAD 24T

Zaagblad tbv ijzerzaag 411010



€ 4

990006
ROLMAAT, 5MTR

Schokbestendig, ABS behuizing met soft-grip afwerking. Beide zijden van het lint zijn afleesbaar. Extreem handig in gebruik, voorzien van goed hanteerbare blokkeerinrichting, riemclip en handkoord.



€ 9

990002
IJZERZAAG KLEIN



€ 19,50

990004
INBUSSET, 9-DLG

1,5-2-2,5-3-4-5-6-8-10mm



€ 17,50

SR1253 1/4" RATEL (MINI)

1/4"

Kunststof behuizing, ultra compacte afmeting, L/R draaiend.
Lengte 140mm, 30Nm, 240rpm.

MINI



€ 55

702216 3/8" MINI RATEL MET SLAGMECHANISME

3/8"

Kunststof behuizing, laag geluid niveau, L/R draaiend. Met een geringe lengte van 145mm en een koppel van 50Nm, de compactste en sterkste in zijn soort en met een toerental van 500 RPM wordt het heel eenvoudig bouten en moeren snel los te draaien. De terugslag van het hamerwerk wordt intern geabsorbeerd, hierdoor kan veilig worden gewerkt, en wordt de pols van de monteur gespaard.



€ 149

RATELS GELUIDGEDEMPT

Kunststof behuizing, laag geluidsniveau, compacte afmetingen, L/R draaiend, 40Nm, 230rpm.

1/4"

3/8"



SR5250 1/4" Ratel, geluidgedempt € 98
SR5251 3/8" Ratel, geluidgedempt € 98

€ 98

RATELS GELUIDGEDEMPT

Kunststof behuizing, laag geluidsniveau, L/R draaiend, 95Nm, 220rpm.

3/8"

1/2"



SR5265 3/8" Ratel € 107
SR5266 1/2" Ratel € 107

€ 107

SR5268 1/2" RATEL HD MET SLAGMECHANISME

1/2"

Heavy Duty slagratelsleutel, kunststof behuizing, L/R draaiend. De terugslag van het hamerwerk wordt intern geabsorbeerd, hierdoor kan veilig worden gewerkt en wordt de pols van de monteur ontzien, 270Nm, 450rpm.



€ 279

SR1200K 1/4" SLAGMOERSLEUTEL (MINI)

1/4"

Koppel instelbaar, L/R draaiend, in 4 standen instelbaar (5-60 Nm), ideaal voor demonteren van gloeibougies, sensoren etc. in koffer met toebehoren, klaar voor gebruik.

Inhoud:

Lange krachtdoppen 8-9-10-11-12-13mm, verlengstukken 50-100mm, kniestuk en Orion nippel

SR1200 Machine los € 98



€ 115

SR1201 3/8" SLAGMOERSLEUTEL / BUTTERFLY

3/8"

L/R draaiend, in 3 standen instelbaar. Draaibare inlaat.



€ 59

SR1202P

3/8" SLAGMOERSLEUTEL

Aluminium behuizing, L/R schakeling eenvoudig te bedienen met doordrukstift, luchtuitlaat via de onderzijde. In 3 standen instelbaar, 250Nm, 9.500rpm.



3/8"

€ 129

SR1208

1/2" SLAGMOERSLEUTEL

Alleskunner met sterk aluminium behuizing, kan tegen een stootje. L/R schakeling eenvoudig te bedienen met doordrukstift, luchtuitlaat via de onderzijde. In 3 standen instelbaar, 700Nm, 8.000rpm.



1/2"

€ 125

702500

1/2" MINI SLAGMOERSLEUTEL

Super compacte kwaliteits machine, ideaal bij minimale werkruimte, bv bij werkzaamheden aan distributie en remklauwen. Compositie behuizing met ultra korte body van slechts 112mm, voorzien van gebruiksvriendelijk One Hand Easy Adjustment. Max koppel van 740Nm, 9.000rpm, in 3 standen instelbaar, gewicht slechts 1,18kg. Luchtuitlaat via de onderzijde.



1/2"

MINI

€ 169

SR5290N

1/2" SLAGMOERSLEUTEL, 1250Nm

Kunststof behuizing met gepolijst aluminium voorhuis, 1250Nm. In 3 standen instelbaar, losdraaiend altijd volle kracht, 10.000rpm. Gewicht slechts 2kg.



1/2"

€ 159

SA25190

MAGNEETSTEUN SLAGMOERSLEUTEL

Voorzien van 2 sterke magneten, geschikt voor het overbergen van een slagmoersleutel, doppen en momentsleutel.



€ 48

SR5270

1/2" SLAGMOERSLEUTEL MET DRAAIBARE KOP

Kunststof behuizing met ultra kort aluminium voorhuis, slechts 70mm bouwhoogte. Met de volledig roteerbare handgreep (360°) en knikbare kop (120°), de meest ideale machine voor moeilijk bereikbare plekken of waar beperkte ruimte beschikbaar is. Maximaal koppel 500Nm, vrij toerental 8000rpm, luchtuitlaat via de zijkant van de machine. Gewicht 1.3kg

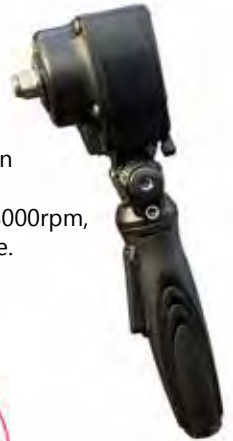

1/2"



€ 159

SR5290SP

1/2" SLAGMOERSLEUTEL + KRACHTDOPPENSET

SR5290N
1/2" SLAGMOERSLEUTEL
Kunststof behuizing met gepolijst aluminium voorhuis, 1250Nm. In 3 standen instelbaar, losdraaiend altijd volle kracht, 10.000rpm. (Normale prijs € 159,-)



SK6929CM
1/2" KRACHTDOPPENSET, 40DLG
Alle maten in kort en lang.
Inhoud: 10-11-12-13-14-15-16-17-18-19-20-21-22-24-25-26-27-30-32mm, kniestuk, verlengstuk 125mm. (Normale prijs € 99,-)

SETPRIJS € 229

702600

3/4" SLAGMOERSLEUTEL

3/4"

Compacte lichtgewicht machine, 2 componenten grip. Composiet behuizing met korte body van slechts 215mm, voorzien van vlakke L/R schakelaar, in 4 standen instelbaar. Max koppel van 1950Nm, 6.500rpm, gewicht slechts 3,25kg. Luchtuitlaat via de onderzijde.



€ 399

SR1218N

3/4" SLAGMOERSLEUTEL

3/4"

L/R schakeling met doordrukstift, maximaal koppel 1500Nm, 5500rpm, 3 standen instelbaar. Gewicht 4,7kg. Luchtuitlaat via de onderzijde.



€ 359

SR1234

1" SLAGMOERSLEUTEL

1"

Aluminium behuizing, hele gunstige kracht/eigengewicht verhouding; 3100Nm/ 9,4kg! 4500rpm in 3 standen instelbaar. Luchtuitlaat via de onderzijde.



€ 649



SR1235

1" SLAGMOERSLEUTEL

1"

Aluminium behuizing, hele gunstige kracht/ eigengewicht verhouding; 3100Nm/ 9,4kg! 4500rpm in 3 standen instelbaar.



€ 649

SR1235L

1" SLAGMOERSLEUTEL

1"

Aluminium behuizing, hele gunstige kracht/ eigengewicht verhouding; 3100Nm/ 9,5kg! 4500rpm in 3 standen instelbaar.



€ 659

SR1004RSS MINI BOORMACHINE 6MM

6 mm

Composiet behuizing, licht in gewicht. Laag geluidsniveau, ultra stil, links/rechts draaiend, 2600rpm, met snelspanboorkop.



MINI

€ 99

SR1012RSS BOORMACHINE 10MM

10 mm

Met kunststof grip en snelspanboorkop, links/rechts draaiend, 1800rpm.



€ 99

SR1015SS BOORMACHINE 10MM

10 mm

Met kunststof grip en snelspanboorkop, 3500rpm.



€ 119

BOORMACHINE 13MM

13 mm

Met kunststof grip, snelspanboorkop, links/rechts draaiend, en extra handgreep



SR1040RSS 700 rpm € 185
SR1045RSS 245 rpm € 198

SWCDD26 MINI BOORMACHINE 6MM

6 mm

Composiet behuizing, licht in gewicht. Laag geluidsniveau en ultra stil, links/rechts draaiend, 2900rpm.



MINI

€ 169

SWCDD48 BOORMACHINE 10MM

10 mm

Composiet behuizing, licht in gewicht. Laag geluidsniveau, ultra stil, links/rechts draaiend, snelspanboorkop, 1700rpm.



€ 169

SWCDD58 BOORMACHINE 10MM

10 mm

Composiet behuizing, licht in gewicht. Laag geluidsniveau en ultra stil, links/rechts draaiend, snelspanboorkop, 750rpm.



€ 169

SWCDD458 BOORMACHINE 13MM

13 mm

Composiet behuizing, licht in gewicht. Laag geluidsniveau en ultra stil, links/rechts draaiend, snelspanboorkop, 750rpm.



incl. side-handle

€ 199

10MM HAAKSE BOORMACHINE 10 mm

Links/rechts draaiend, 1400rpm.



SR1006R Met tandkransboorkop € 99
SR1006RSS Met snelspanboorkop € 112

VEERBALANCERS

Veerspanning instelbaar

SRB0615	0,6-1,5 kg	1,6m	€ 29
SRB1020	1,0-2,0 kg	1,6m	€ 29
SRB1530	1,5-3,0 kg	1,5m	€ 49
SRB3050	3,0-5,0 kg	1,5m	€ 59
SRB4070	4,0-7,0 kg	1,5m	€ 119
SRB6090	6,0-9,0 kg	1,5m	€ 199



SR1008NSS 10 mm BOORMACHINE 10MM, RECHT

Met kunststof grip en snelspanboorkop, rechts-draaiend, 2000rpm.



€ 109

TANDKRANSBOORKOP MET SLEUTEL

SA1010ZB 10 mm (3/8" x 24) € 17,00
SA1013ZB 13 mm (3/8" x 24) € 29,00



SNELSPANBOORKOP

SA1010SS 10 mm (3/8" x 24) € 19,50
SA1013SS 13 mm (3/8" x 24) € 39,00



SWCCP45 SCHROEVENDRAAIER 750RPM / 7Nm

Instelbaar, met kunststof grip en snelspankop, links/rechts draaiend, 750rpm, max 7Nm



€ 199

SWCDP58 SCHROEVENDRAAIER, 750RPM / 13Nm

Composiet behuizing, licht in gewicht. Laag geluidsniveau en ultra stil, 750rpm, links/rechts draaiend, vast ingesteld koppel 13Nm, bithouder.



€ 169

SWCCP48 SCHROEVENDRAAIER 1700RPM / 7Nm

Instelbaar, met kunststof grip en snelspankop, links/rechts draaiend, 1700rpm, max 7Nm



€ 199

SWCCP58 SCHROEVENDRAAIER 750RPM / 13Nm

Instelbaar, met kunststof grip en snelspankop, links/rechts draaiend, 750rpm, max 13Nm



€ 199

SR5638K

MINI SCHUURMACHINE, 50+75MM PAD
IN KOFFER MET ACC.

Ø 50+75 mm

Kunststof behuizing, licht in gewicht, in koffer met toebehoren; steunpad klittenband 50mm (SA563850), steunpad klittenband 75mm (SA563975), set á 10 stuks schuurvellen 50mm (T050.. serie), set á 10 stuks schuurvellen 75mm (T075.. serie), Orion nippel JWL522312, spangereedschap, klaar voor gebruik. As: 5/16" UNF buitendraad. 15.000rpm.

SR5638 Machine zonder accessoires: € 99



Ø75mm/
SA563975



Ø50mm/ SA563850



10 x Ø75mm



10 x Ø50mm



2,5MM
EXCENTRISCH
ROTTEREND

€ 135

SR9600V

EXCENTRISCHE SCHUURMACHINE, 150MM
5MM ORBIT

Ø 150 mm

Sterke kunststof behuizing, met en zonder stofafzuiging te gebruiken. 10.000rpm, traploos instelbaar, gewicht slechts 900gr. Aansluiting tbv stofafzuiging is Ø 30mm. Incl steunpad klittenband (SA961516) en spangereedschap. As: 5/16" UNF binnendraad.



5MM
EXCENTRISCH
ROTTEREND

€ 219

SR9602V

EXCENTRISCHE SCHUURMACHINE, 150MM
2,5MM ORBIT

Ø 150 mm

Sterke kunststof behuizing, met en zonder stofafzuiging te gebruiken. 10.000rpm, traploos instelbaar, gewicht slechts 900gr. Aansluiting tbv stofafzuiging is Ø 30mm. Incl steunpad klittenband (SA961516) en spangereedschap. As: 5/16" UNF binnendraad.



2,5MM
EXCENTRISCH
ROTTEREND

€ 219

SR9615

MINI SCHUURMACHINE, 75MM PAD

Ø 75 mm

Kunststof behuizing, incl. steunpad klittenband 75mm (SA9615PAD) 10.000rpm, excentrische slag 2,5mm. As: 5/16" UNF binnendraad.

2,5MM
EXCENTRISCH
ROTTEREND



€ 145

SA9600Z

STOFZAK MET AFZUIGSLANG

Flexibel manchet, inwendig Ø 30mm. Tbv SR9600V, SR9602V



€ 29,50

704025

SCHUURMACHINE 150MM (2,5MM ORBIT)

Ø 150 mm

Excentrisch roterend, 150mm velcro steunpad (5/16" UNF buitendraad), orbitale slag 2,5mm, centrale afzuiging, 11000rpm, achter uitlaat, L=215mm, gewicht 0,9kg, luchtinlaat 1/4".



2,5MM
EXCENTRISCH
ROTTEREND

€ 188

704050

SCHUURMACHINE 150MM (5MM ORBIT)

Ø 150 mm

Excentrisch roterend, 150mm velcro steunpad (5/16" UNF buitendraad), orbitale slag 5mm, centrale afzuiging, 11000rpm, achter uitlaat, L=215mm, gewicht 0,9kg, luchtinlaat 1/4".



5MM
EXCENTRISCH
ROTTEREND

€ 188

704100

SCHUURMACHINE 203MM (5MM ORBIT) 10.000RPM

Ø 203 mm

Excentrisch roterend, 203mm velcro steunpad, orbitale slag 5mm, centrale afzuiging, 10.000rpm, gewicht 2,0kg, luchtinlaat 1/4".



5MM
EXCENTRISCH
ROTTEREND

€ 399

704200

SCHUURMACHINE 203MM (5MM ORBIT) 900RPM

Ø 203 mm

Gear driven, 203mm velcro steunpad, orbitale slag 5mm centrale afzuiging, 900rpm, gewicht 2,0kg, luchtinlaat 1/4".



5MM
GEAR DRIVEN

€ 399

704010

SCHUURMACHINE 30MM (3MM ORBIT)

Ø 30 mm

Excentrisch, 30mm velcro steunpad (M10 x 1,25P), orbitale slag 3mm, 7500rpm, achteruitlaat (richting instelbaar), L=170mm, gewicht 0,75kg, luchtinlaat 1/4", luchtverbruik 113L/min.



704980
Ø30mm, M10 x 1,25P € 11

€ 99

STEUNPADS VELCRO



704910 Ø150mm, multi hole, 5/16" UNF buitendraad € 28

704920 Ø203mm, 8 gaten incl 6x montagebout € 59

SR9670K

**BANDSCHUURMACHINE 10MM
IN KOFFER MET ACC.**

10 mm

Instelbare werkhoek, 16.000rpm, in koffer met toebehoren, incl schuurbanden, 3 sets á 10 stuks schuurbanden (10mm) met verschillende korrel (T5902.. serie), Orion nippel JWL522312, instelgereedschap, klaar voor gebruik.

SR9670 Machine los € 105



SR9676

BANDSCHUURMACHINE 20MM

20 mm

Instelbare werkhoek, 16.000rpm



SR5630K

**MINI SLIJPER INCL. 50+75MM
ROLOC PAD IN KOFFER MET ACC.**

Ø 50+75 mm

Kunststof behuizing, licht in gewicht, in koffer met toebehoren; Steunschijf 50mm (SA963050), steunschijf 75mm (SA963075), schuurschijfjes 50mm/ K80 10stuks, schuurschijfjes 75mm/ K80 10 stuks, Orion nippel JWL522312, spangereedschap, klaar voor gebruik. As: 1/4" UNC buitendraad. 15.000rpm.

SR5630 Machine los (incl. Ø50mm + Ø75mm pad) € 99



SR1400K

SLIJPER IN KOFFER MET ACCESSOIRES

Ø 115+125 mm

Eenhandsslijper, kunststof behuizing, wordt geleverd met steunpads waarop fiberschijven gemonteerd kunnen worden, links/rechts draaiend, rpm instelbaar, incl 10 fiberschijven en spangereedschap, 14.000rpm.

SR1400 Machine los € 99



SCHUURBANDEN 10MM

10 mm

- T59020040** 10x 330mm K40, 10 pcs € 12,50
T59020060 10x 330mm K60, 10 pcs € 12,50
T59020080 10x 330mm K80, 10 pcs € 12,50
T59020120 10x 330mm K120, 10 pcs € 12,50



SCHUURBANDEN 20MM

20 mm

- T59050040** 20x 520mm K40, 10 pcs € 16,00
T59050060 20x 520mm K60, 10 pcs € 16,00
T59050080 20x 520mm K80, 10 pcs € 16,00
T59050120 20x 520mm K120, 10 pcs € 16,00



SCHUURPAPIER KLITTENBAND

Ø 37 mm



- 714260** Schuurpapier Ø37mm, K1200, 25x € 7,90
714262 Schuurpapier Ø37mm, K1500, 25x € 7,90
714264 Schuurpapier Ø37mm, K2000, 25x € 7,90

SCHUURPAPIER KLITTENBAND

Ø 50 mm



- TA0500040** Schuurpapier Ø50mm K 40, 10x € 5,50
TA0500060 Schuurpapier Ø50mm K 60, 10x € 5,50
TA0500080 Schuurpapier Ø50mm K 80, 10x € 5,50
TA0500120 Schuurpapier Ø50mm K120, 10x € 5,50
TA0500150 Schuurpapier Ø50mm K150, 10x € 5,50
TA0500180 Schuurpapier Ø50mm K180, 10x € 5,50
TA0500240 Schuurpapier Ø50mm K240, 10x € 5,50
TA0500400 Schuurpapier Ø50mm K400, 10x € 5,50
TA0500500 Schuurpapier Ø50mm K500, 10x € 5,50

SCHUURPAPIER KLITTENBAND

Ø 75 mm



- TA0750040** Schuurpapier Ø75mm K 40, 10x € 6,50
TA0750060 Schuurpapier Ø75mm K 60, 10x € 6,50
TA0750080 Schuurpapier Ø75mm K 80, 10x € 6,50
TA0750120 Schuurpapier Ø75mm K120, 10x € 6,50
TA0750150 Schuurpapier Ø75mm K150, 10x € 6,50
TA0750180 Schuurpapier Ø75mm K180, 10x € 6,50
TA0750240 Schuurpapier Ø75mm K240, 10x € 6,50
TA0750400 Schuurpapier Ø75mm K400, 10x € 6,50
TA0750500 Schuurpapier Ø75mm K500, 10x € 6,50
TA0750800 Schuurpapier Ø75mm K800, 10x € 7,50
TA0751500 Schuurpapier Ø75mm K1500, 10x € 7,50
TA0752500 Schuurpapier Ø75mm K2500, 10x € 7,50



SCHUURPAPIER

VOOR NAT EN DROOG SCHUREN
KLITTENBAND

Ø 150 mm



- 714361** Schuurpapier (15gaten) Ø150mm K 80, 100x € 59
714365 Schuurpapier (15gaten) Ø150mm K120, 100x € 59
714367 Schuurpapier (15gaten) Ø150mm K150, 100x € 59
714369 Schuurpapier (15gaten) Ø150mm K180, 100x € 59
714371 Schuurpapier (15gaten) Ø150mm K240, 100x € 59
714373 Schuurpapier (15gaten) Ø150mm K320, 100x € 59
714376 Schuurpapier (15gaten) Ø150mm K400, 100x € 59
714379 Schuurpapier (15gaten) Ø150mm K500, 100x € 59
714383 Schuurpapier (15gaten) Ø150mm K800, 50x € 69
714385 Schuurpapier (15gaten) Ø150mm K1000, 50x € 69
714387 Schuurpapier (15gaten) Ø150mm K1200, 50x € 69
714389 Schuurpapier (15gaten) Ø150mm K1500, 50x € 69

SCHUURPAPIER KLITTENBAND

Ø 203 mm



- 714281** Schuurpapier (9 gaten) Ø203mm, K40, 50x € 79
714282 Schuurpapier (9 gaten) Ø203mm, K60, 50x € 79
714283 Schuurpapier (9 gaten) Ø203mm, K80, 100x € 129
714284 Schuurpapier (9 gaten) Ø203mm, K120, 100x € 129
714285 Schuurpapier (9 gaten) Ø203mm, K180, 100x € 129
714286 Schuurpapier (9 gaten) Ø203mm, K240, 100x € 129
714287 Schuurpapier (9 gaten) Ø203mm, K320, 100x € 129

FIBERSCHIJVEN

Ø 115 mm



- 714451 Fiberschijf Ø115mm (22mm) K36, 50x € 45
- 714453 Fiberschijf Ø115mm (22mm) K60, 50x € 33
- 714455 Fiberschijf Ø115mm (22mm) K80, 50x € 28
- 714457 Fiberschijf Ø115mm (22mm) K120, 50x € 29

FIBERSCHIJVEN

Ø 125 mm



- 714481 Fiberschijf Ø125mm (22mm) K36, 50x € 47
- 714483 Fiberschijf Ø125mm (22mm) K60, 50x € 38
- 714485 Fiberschijf Ø125mm (22mm) K80, 50x € 33
- 714487 Fiberschijf Ø125mm (22mm) K120, 50x € 32

SCHUURSCHIJVEN Ø50MM ROLOC

Ø 50 mm



- 714401 Schuurschijf Ø50mm K36, 50x € 52
- 714403 Schuurschijf Ø50mm K60, 50x € 52
- 714405 Schuurschijf Ø50mm K80, 50x € 52
- 714407 Schuurschijf Ø50mm K120, 50x € 52

LAMELLENSCHIJVEN

Ø115MM (22MM) AFGESCHUIND

Ø 115 mm



- 714501 Lamellenschijf K40, 10x € 26
- 714503 Lamellenschijf K60, 10x € 26
- 714505 Lamellenschijf K80, 10x € 26

LAMELLENSCHIJVEN

Ø125MM (22MM) AFGESCHUIND

Ø 125 mm



- 714511 Lamellenschijf K40, 10x € 32,50
- 714513 Lamellenschijf K60, 10x € 32,50
- 714515 Lamellenschijf K80, 10x € 32,50

SCHUURSCHIJVEN Ø75MM ROLOC

Ø 75 mm



- 714411 Schuurschijf Ø75mm K36, 50x € 77
- 714413 Schuurschijf Ø75mm K60, 50x € 77
- 714415 Schuurschijf Ø75mm K80, 50x € 77
- 714417 Schuurschijf Ø75mm K120, 50x € 77

SCHUURVLIES

Ø50MM ROLOC

Ø 50 mm



- 714423 Schuurvlies Ø50mm, medium, 10x € 29,50

SCHUURLINNEN

50MM, 50MTR



- 714241 Schuurlinnen 50mm K80 € 54
- 714243 Schuurlinnen 50mm K120 € 54
- 714245 Schuurlinnen 50mm K150 € 54
- 714247 Schuurlinnen 50mm K240 € 54

SCHUURVLIES

Ø75MM ROLOC

Ø 75 mm



- 714433 Schuurvlies Ø75mm, medium, 10x € 41,50
- 714431 Schuurvlies Ø75mm, grof, 10x € 41,50

SR1304 STIFTSLIJPER

6 mm

Kunststof behuizing, 0,4kW, 25.000rpm, 6mm spantang, incl spangereedschap.



€ 75

SR1304W HAAKSE STIFTSLIJPER

6 mm

Kunststof behuizing, 0,4kW, 25.000rpm, 6mm spantang, incl spangereedschap.



€ 106

SR1308 STIFTSLIJPER HD

6 mm

Kunststof behuizing met regelbaar toerental en draaibare inlaat. Geluidgedempt, 0,6kW/ 20.000rpm, 6mm spantang, incl spangereedschap. Lengte 198mm, gewicht 0,71kg. 139



€ 139

SR1308W STIFTSLIJPER HAAKS, HD

6 mm

Kunststof behuizing met regelbaar toerental en draaibare inlaat. Geluidgedempt, 0,4kW/ 20.000rpm, 6mm spantang, incl spangereedschap. Lengte 182mm, gewicht 0,62kg.



€ 179

SR1334L STIFTSLIJPER, LANG

6 mm

Verlengde uitvoering, voorzien van 3 laggers. Lengte en Ø van smalle gedeelte (van spantang tot handgreep) is 150/18mm, 6mm spantang, incl spangereedschap, 28.000rpm.



€ 159

SR1584 BAND OPRUWMACHINE

Met deze machine is het eenvoudig om de band op te ruwen, hierdoor zal de plakker beter hechten. Met handig kliksysteem is de meegeleverde schuurkom eenvoudig te wisselen (art nr schuurkom SA1584: € 28,-). Rubber bescherming, 2500rpm



€ 179

SR1332 STIFTSLIJPER HOOGTOERIG

3 mm

Hoogtoerige slijper met 3mm spantang, incl spangereedschap, 60.000rpm.



€ 139



734203

STIFFREZENSET 3DLG

HM/ Hardmetaal, 6mm schacht, DIN 8033

734216 Cilindrisch met kopvertanding (Vorm B), kopdikte 10mm

734326 Kogel (Vorm D), kopdikte 10mm

734526 Boom met spitse kop (Vorm G), kopdikte 10mm



6 mm

€ 58

734205

STIFFREZENSET 5DLG

HM/ Hardmetaal, 6mm schacht, DIN 8033

734216 Cilindrisch met kopvertanding (Vorm B), kopdikte 10mm

734226 Cilindrisch met ronde kop (Vorm C), kopdikte 10mm

734326 Kogel (Vorm D), 10mm

734426 Boom met ronde kop (Vorm F), kopdikte 10mm

734526 Boom met spitse kop (Vorm G), kopdikte 10mm



6 mm

€ 86

734210

STIFFREZENSET 10DLG

HM/ Hardmetaal, 6mm schacht, DIN 8033

734212 Cilindrisch met kopvertanding (Vorm B), kopdikte 6mm

734218 Cilindrisch met kopvertanding (Vorm B), kopdikte 12mm

734222 Cilindrisch met ronde kop (Vorm C), kopdikte 6mm

734228 Cilindrisch met ronde kop (Vorm C), kopdikte 12mm

734322 Kogel (Vorm D), kopdikte 6mm

734328 Kogel (Vorm D), kopdikte 12mm

734422 Boom met ronde kop (Vorm F), kopdikte 6mm

734428 Boom met ronde kop (Vorm F), kopdikte 12mm

734522 Boom met spitse kop (Vorm G), kopdikte 6mm

734528 Boom met spitse kop (Vorm G), kopdikte 12mm



6 mm

€ 155

STIFFREZEN

HM/ Hardmetaal, 6mm schacht, l=64mm, DIN 8033

6 mm

Cilindrisch met kopvertanding (Vorm B)

734212 k= 6mm € 14,00

734214 k= 8mm € 17,00

734216 k= 10mm € 20,50

734218 k= 12mm € 29,00



Cilindrisch met ronde kop (Vorm C)

734222 k= 6mm € 14,00

734224 k= 8mm € 17,00

734226 k= 10mm € 20,50

734228 k= 12mm € 29,00



Kogel (Vorm D)

734322 k= 6mm € 14,00

734324 k= 8mm € 17,00

734326 k= 10mm € 20,50

734328 k= 12mm € 29,00



Boom met ronde kop (Vorm F)

734422 k= 6mm € 14,00

734424 k= 8mm € 17,00

734426 k= 10mm € 20,50

734428 k= 12mm € 29,00



Boom met spitse kop (Vorm G)

734522 k= 6mm € 14,00

734526 k= 10mm € 20,50

734528 k= 12mm € 29,00



Kegel met afgeronde kop (Vorm L)

734624 k= 8mm € 21,50

734626 k= 10mm € 27,00

734628 k= 12mm € 31,00



734753

STIFFREZEN SET ALU-VERTANDING, 3DLG

HM/ Hardmetaal, 6mm schacht, DIN8033

Voor verspanen van aluminium, aluminium legeringen, non-ferro metalen en kunststof

Inhoud; Vorm B/ C/ F (12mm kop)



6 mm

€ 93

STIFFREZEN MET ALUMINIUM VERTANDING

HM/ Hardmetaal, 6mm schacht, kopdikte/-hoogte 12/25mm, lengte 70mm, DIN8033

6 mm

734768 Cilindrisch met kopvertanding (vorm B) € 36,50

734778 Cilindrisch met ronde kop (vorm C) € 31,00

734798 Boom met ronde kop (vorm F) € 27,00



STIFFREZEN LANG

HM/ Hardmetaal, 6mm schacht, DIN 8033

6 mm

Cilindrisch met kopvertanding (Vorm B)

734662	kopdikte 6mm, l=150mm	€ 35,00
734664	kopdikte 8mm, l=170mm	€ 24,50
734666	kopdikte 10mm, l=170mm	€ 26,00
734668	kopdikte 12mm, l=175mm	€ 40,50

Cilindrisch met ronde kop (Vorm C)

734672	kopdikte 6mm, l=150mm	€ 37,00
734674	kopdikte 8mm, l=170mm	€ 24,50
734676	kopdikte 10mm, l=170mm	€ 26,00
734678	kopdikte 12mm, l=175mm	€ 40,00

Kogel (Vorm D)

734684	kopdikte 8mm, l=170mm	€ 21,00
734686	kopdikte 10mm, l=170mm	€ 24,50
734688	kopdikte 12mm, l=175mm	€ 29,00

Boom met ronde kop (Vorm F)

734702	kopdikte 6mm, l=150mm	€ 36,50
734706	kopdikte 10mm, l=170mm	€ 25,50
734708	kopdikte 12mm, l=175mm	€ 36,50

Boom met spitse kop (Vorm G)

734716	kopdikte 10mm, l=170mm	€ 27,00
734718	kopdikte 12mm, l=175mm	€ 36,50

Kegel met afgeronde kop (Vorm L)

734726	kopdikte 10mm, l=170mm	€ 32,50
734728	kopdikte 12mm, l=175mm	€ 42,00



STIFFREZEN 3MM

HM/ Hardmetaal, 3mm schacht, DIN 8033

3 mm

Cilindrisch met kopvertanding (Vorm B)

735021	kopdikte 3mm, l=38mm	€ 8,00
735022	kopdikte 6mm, l=48mm	€ 12,00

Cilindrisch met ronde kop (Vorm C)

735025	kopdikte 3mm, l=38mm	€ 8,00
735026	kopdikte 6mm, l=48mm	€ 12,00

Kogel (Vorm D)

735029	kopdikte 3mm, l=38mm	€ 7,00
735030	kopdikte 6mm, l=40mm	€ 12,00

Druppel/ Ovaal (Vorm E)

735033	kopdikte 3mm, l=38mm	€ 7,00
735034	kopdikte 6mm, l=40mm	€ 13,00

Boom met ronde kop (Vorm F)

735037	kopdikte 3mm, l=38mm	€ 8,00
735038	kopdikte 6mm, l=48mm	€ 12,00

Boom met spitse kop (Vorm G)

735041	kopdikte 3mm, l=38mm	€ 8,00
735042	kopdikte 6mm, l=48mm	€ 11,00

Vlam (Vorm H)

735045	kopdikte 3mm, l=38mm	€ 7,00
--------	----------------------	--------

Kegel/ Cone (Vorm M)

735048	kopdikte 3mm, l=38mm	€ 7,00
735049	kopdikte 6mm, l=48mm	€ 12,00



735015

STIFFREZENSET 3MM 15DLG

3 mm

HM/ Hardmetaal, 3mm schacht, DIN 8033

Inhoud: B/ C/ D/ E/ F/ G/ M (in 3 en 6mm kopdikte)
+ H (3mm kopdikte)

Inclusief alle
fren zoals
hiernaast
afgebeeld



€ 125

SR1350SET

MINI HAAKSE SLIJPER SET 50MM

Ø 50 mm

Zeer handzaam en compact vormgegeven. Ideaal voor moeilijk bereikbare plekken. Incl. verbruiksmateriaal, set á 5 stuks afbraamschijven (714603), spangereedschap, asgat 10mm, 12.000rpm.



714603 (5x incl.)
(Optie / option: 714613)

€ 135

SR1355

HAAKSE SLIJPER 125MM

Ø 125 mm

Max. 12.000rpm, 0,5kW, asgat 22mm, M14, incl spangereedschap.



€ 145

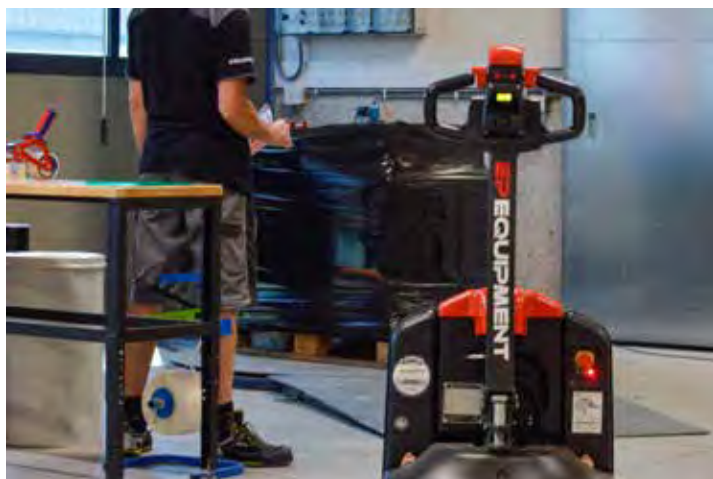

SR1365

HAAKSE SLIJPER 125MM, HEAVY DUTY

Ø 125 mm

Heavy Duty, 11.000rpm, 1kW, asgat 22mm, M14, incl spangereedschap.



€ 269

SR1367

HAAKSE SLIJPER 180MM, HEAVY DUTY

Ø 180 mm

Heavy Duty, 7.500rpm, 1,5kW, asgat 22mm, 5/8", incl spangereedschap.



€ 455

SR1501SET

DOORSLIJPMACHINE 75MM

Ø 75 mm

Met beschermkap, 10 schijven (75mm) meegeleverd (SA1500TM), 22.000rpm, 0,4kW, asgat 10mm, M6, incl spangereedschap.



SA1500TM (10pcs)

€ 49

SR1342SET

DOORSLIJPER HAAKS 100MM

Ø 100 mm

Ideaal voor moeilijk bereikbare plekken. Incl. verbruiksmateriaal, set á 5 stuks doorslijpschijven, spangereedschap, links/rechts draaiend, 12.000rpm, asgat 16mm, Klaar voor gebruik.



€ 179

SR1340SET

DOORSLIJPER HAAKS LANG 100MM

Ø 100 mm

Ideaal voor moeilijk bereikbare plekken. Incl. verbruiksmateriaal, set á 5 stuks doorslijpschijven, spangereedschap, links/rechts draaiend, 12.000rpm, asgat 16mm, Klaar voor gebruik.

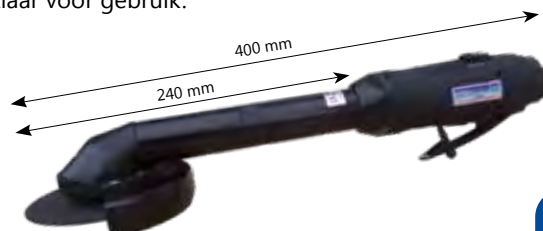

€ 179

STEUNPADS

Ø 50 mm

SA963850 Steunpad Ø50mm klittenband, M6 buitendraad € 17,00

SA563850 Steunpad Ø50mm klittenband, 5/16"UNF binnendraad € 19,00

SA963050 Steunpad Ø50mm roloc, 1/4"UNC binnendraad € 11,00

SA1310 Adapter 6mm stift x 1/4"UNC (ext) € 3,00



SA963050 icm SA1310

STEUNPADS

Ø 75 mm

SA963975 Steunpad Ø75mm klittenband, M6 buitendraad € 17,00

SA9615PAD Steunpad Ø75mm klittenband, 5/16"UNF buitendraad € 22,00

SA563975 Steunpad Ø75mm klittenband, 5/16"UNF binnendraad € 19,00

SA9625 Steunpad Ø75mm roloc, met klittenband rug, dikte 20mm € 8,00

SA9620 Steunpad Ø75mm klittenband, 6mm spanstift € 7,00

SA563575 Steunpad Ø75mm roloc, 5/16"UNF binnendraad € 12,00

SA963075 Steunpad Ø75mm roloc, 1/4"UNC binnendraad € 12,50

SA1310 Adapter 6mm stift x 1/4"UNC (ext) € 3,00



POETS SPONZEN GEWAFELD

Ø 80 mm

SA9041 Spons Ø80mm wafelstructuur klittenband, (oranje/medium) € 5,50



SA9040 Spons Ø80mm wafelstructuur klittenband, (wit/soft) € 5,50



SA9042 Spons Ø80mm wafelstructuur klittenband, (zwart/extrasoft) € 5,50



POETS SPONZEN VLAK

Ø 80 mm

SA9045 Spons Ø80mm afgerond klittenband, (oranje/medium) € 5,50



SA9047 Spons Ø80mm afgerond klittenband, (wit/soft) € 5,50



SA9046 Spons Ø80mm afgerond klittenband, (zwart/extrasoft) € 5,50



INTERFACE PAD

Ø 80 mm

SA9120 Interface pad Ø80mm, klittenband € 4,50



POETSVACHT

Ø 80 mm

SA9050 Poetsvacht Ø80mm, klittenband € 7,00



STEUNPADS M14

Ø 125 mm

SA9011 Steunpad Ø125mm klittenband (soft), M14 binnendraad € 10,50



SA9017 Steunpad Ø125mm klittenband, M14 binnendraad € 10,50



POETS SPONZEN GEWAFELD

Ø 150 mm

SA9021 Spons Ø150mm wafelstructuur, klittenband (oranje/medium) € 7,50



SA9020 Spons Ø150mm wafelstructuur, klittenband (wit/soft) € 7,50



SA9022 Spons Ø150mm wafelstructuur, klittenband (zwart/extrasoft) € 7,50



STEUNPADS M14

Ø 150 mm

SA9012 Steunpad Ø150mm klittenband (soft), M14 binnendraad € 10,50



SA9016 Steunpad Ø150mm klittenband, M14 binnendraad € 10,50



POETS SPONZEN VLAK

Ø 150 mm

SA9025 Spons Ø150mm afgerond, klittenband (oranje/medium) € 9,50



SA9026 Spons Ø150mm afgerond, klittenband (wit/soft) € 9,50



SA9027 Spons Ø150mm afgerond, klittenband (zwart/extrasoft) € 9,50



STEUNPADS 5/16"UNF

Ø 150 mm

SA961510 Steunpad Ø150mm klittenband, 5/16"UNF buitendraad € 22,00



SA961516 Steunpad Ø150mm klittenband, 6 gaten, 5/16"UNF buitendraad € 22,00



POETSVACHT

Ø 150 mm

SA9030 Poetsvacht Ø150mm, klittenband € 9,50



POETSPASTA

SAG4400 Poetspasta € 35,00



SR5635K

POETSMACHINE 75MM, IN KOFFER MET ACC.

Ø 75 mm

Kunststof behuizing, licht in gewicht, in koffer met toebehoren, spangereedschap, klaar voor gebruik, as: 5/16" UNF buitendraad, 2500rpm, klittenband en Roloc steunpad.



SA563575



SA563975

Inhoud:

- SR5635** Poetsmachine 75mm
- SA563575** Rolocpad 75mm
- SA563975** Steunpad 75mm
- SA9047** Poetsspons vlak
- SA9040** Poetssp. wafelstructuur wit/ soft
- SA9050** Poetsvacht
- JWL522312** Orion nippel 1/4"

SR5635 Machine los (incl. SA563975) € 99

€ 135

SR5635KIT

KOPLAMP POLIJSTKIT IN KOFFER

Ø 75 mm



De perfecte samenstelling voor het polijsten van kunststof koplampunits, in koffer en klaar voor gebruik, 2500rpm, regelbaar, as: 5/16" UNF buitendraad, klittenband steunpad.



Inhoud:

- SR5635** Poetsmachine 75mm
- SA563975** Steunpad 75mm
- SAG4400** Poetspasta 400gr
- SA9040** Poetsspons wafelstructuur wit/ soft
- SA9042** Poetsspons wafelstructuur zwart/ extra soft
- D51080** Poetsdoek micro
- SA9120** Interface pad
- TA0750800** Schuurpapier 75mm, K800 (10st)
- TA0751500** Schuurpapier 75mm, K1500 (10st)
- TA0752500** Schuurpapier 75mm, K2500 (10st)
- JWL522312** Orion nippel 1/4"

SR5635 Machine los (incl. SA563975) € 99

€ 169

SR1442SET

POETSMACHINE 150MM

Ø 150 mm

Licht in gewicht, met extra handgreep. Incl. verbruiksmateriaal spangereedschap, klittenband steunpad, klaar voor gebruik, 4.500rpm.

SR1442 Machine los (incl. SA9017) € 195



SA9020
Ø150mm

SA9030
Ø150mm

SA9026
Ø150mm



SA9017,
Ø125mm, M14(int)

€ 219

SR1580K

SIERSTRIPSLIJPER IN KOFFER

Door het lage toerental (4.000rpm) geschikt voor het verwijderen van o.a. stickermateriaal, in koffer met toebehoren, incl caramel-/ rubberschijf SA1580 (3x), Orion nippel JWL522312, klaar voor gebruik.



SR1580 Machine los (Inclusief 1x SA1580) € 75

€ 95

SA158P

ADAPTER TBV SA1580

Adapter tbv eraser gum caramelschijf SA1580, 6mm stift



€ 4,⁵⁰

SA1580

ERASER GUM/ CARAMELSCHIJF

M6 (ext.)



€ 9,⁵⁰

706171

MULTISLIJPER IN KOFFER

De perfecte machine voor het verwijderen van undercoating, lakken en roest. Het gebruik van deze machine levert een zandstraal effect op; de borstels zijn voorzien van talloze veerstalen draadkrammen, deze zijn aan het uiteinde gehoekt, geslepen en gehard. Door de combinatie van veel kracht bij een laag toerental ontstaat weinig wrijving en hitte. Hierdoor smelten uitgeharde coatings niet waardoor de borstel schoon blijft en restanten droog en effectief verwijderd worden. Tevens ontstaan op deze wijze geen giftige dampen. De borstels zijn flexibel en passen zich moeiteloos aan het oppervlakprofiel aan, ook op moeilijk bereikbare plekken.

Tevens te gebruiken i.c.m. een rubber sticker remover; eenvoudig stickers en lijmresten verwijderen van (gelakt) plaatwerk. Door minimale hitte ontwikkeling geen kans op lakbeschadiging.

Koffer inhoud:

714812	Borstelband 11mm, fijn/groen	€ 18,00
714814	Borstelband 11mm, grof/zwart	€ 18,00
714822	Borstelband 23mm, fijn/groen	€ 18,00
714824	Borstelband 23mm, grof/zwart	€ 18,00
714850	Cleanschijf (6x)	€ 9,50 (p st)
714832	Eraser gum, standaard 23mm	€ 22,00
714834	Eraser gum, watergedragen lakken 23mm	€ 22,00
714816	Adapter 11mm	€ 16,00
714836	Adapter 23mm	€ 16,00
714852	Adapter voor cleanschijf (enkel)	€ 16,00
714853	Adapter voor cleanschijf (dubbel)	€ 16,00



€ 399

SR1506NK HAKHAMER, 10MM

In koffer met toebehoren, beitels: SA102, 103, 104, 105, veer SA384 (2x), veiligheidsbril SA395, Orion nippel JWL522312, klaar voor gebruik.



SR1506N Machine los (incl. 1x SA384) € 39,90



€ 85

SR1508K HAKHAMER, 10MM, HEAVY DUTY

In koffer met toebehoren, beitels: 2x SA102, veer SA384 (2x), veiligheidsbril SA395, Orion nippel JWL522312, klaar voor gebruik.



SR1508 Machine los (incl. 1x SA384) € 95,00



€ 129

BEITELS EN ACCESSOIRES BEITELS 10 x 175MM

SA101 Beitel, 20 mm € 8,00

SA102 Beitel, 20 mm € 8,50

SA103 Beitel, 20 mm € 8,50

SA104 Beitel, 20 mm € 8,50

SA105 Beitel, 16 mm € 8,50

SA106 Beitel, 40 mm € 12,50

SA384 Veer € 2,00

SA395 Veiligheidsbril € 7,50

SR1387 GRAVEERSTIFT

Voor het graveren van naam, serienummers etc. op bv. metaal en aluminium.



€ 115

SR1572 KNABELSCHAAR

Voor het eenvoudig uitsnijden van plaatwerk, max plaatdikte 1,25mm.



€ 99

SR1570 BLIKSCHAAR

Voor het eenvoudig uitsnijden van plaatwerk, max plaatdikte 1mm.



€ 95

SR1574 PONS- EN VERZETTANG

Verzetrand 12mm, boordiameter 5mm, plaatdikte max 1mm



€ 89

SR1511

NAALDBIKHAMER RECHT

Voor het verwijderen van roest, corrosie en oude coatings, 3300 slagen per minuut. Incl. 19 ronde naalden (SA1510BR).



€ 179

SW1212000

NAALDBIKHAMER, RECHT, HEAVY DUTY

Heavy Duty uitvoering, voor het verwijderen van roest, corrosie en oude coatings, 3000 slagen per minuut. Incl. 19 platte naalden (SA1510FL).



€ 459

SR1510

NAALDBIKHAMER

Voor het verwijderen van roest, corrosie en oude coatings, 3300 slagen per minuut. Incl. 19 ronde naalden (SA1510BR).



€ 179

SW1232100

NAALDBIKHAMER HEAVY DUTY

Heavy Duty uitvoering, voor het verwijderen van roest, corrosie en oude coatings, 3000 slagen per minuut. Incl. 19 platte naalden (SA1510FL).



€ 459

NAALDENSETS

Naaldensets (19st)
tbv naaldbikhamers,
leverbaar in 3 varianten.



 **SA1510BR** rond, 19st € 21,50

 **SA1510FL** plat, 19st € 21,50

 **SA1510PO** punt, 19st € 21,50

PUNTLASBOREN

TBV SR1568



734830 8mm HSS (44mm) € 10,00

734834 8mm HSS-E TiALN (44mm) € 27,00

PUNTLASBOREN



734802 6mm HSS (66mm) € 7,00

734806 8mm HSS (79mm) € 9,00

734810 8mm HSS-E TiALN (79mm) € 19,50

734818

PUNTLASFREES

10mm HSS (72mm)



€ 17

SR1568

PUNTLASBOORMACHINE

Voorzien van vaste beugel, diepte instelbaar. Standaard met puntlasboor 734830.



€ 239

SR1615

BLINDKLINKNAGELTANG 4,8MM

Geschikt voor nagels tot 4,8mm kopgrootte (RVS max 4mm).
Incl neusstukken 2,4/ 3,2/ 4,0/4,8mm.



€ 109

ONDERDELEN

BLINDKLINKNAGELTANG SR1615

LOSSE BEK

SP161504

5x10 tbv SR1615 (per stuk)



€ 9,00

NOSE PIECE

SP161501A

4,8mm (gat Ø tbv trekstift: ± 3,3mm)



€ 5,00

SP161501B

4,0mm (gat Ø tbv trekstift: ± 2,7mm)



€ 5,00

SP161501C

3,2mm (gat Ø tbv trekstift: ± 2,1mm)



€ 5,00

SP161501D

2,4mm (gat Ø tbv trekstift: ± 1,5mm)



€ 5,00

(* foto indicatief)

SR1567K

MULTISNIJDER IN KOFFER MET ACCESSOIRES

In koffer met toebehoren; mes kort SA33A (2x), mes SA38, klaar voor gebruik (tevens geschikt voor de meeste Fein toebehoren) incl spangereedschap.

SR1567 Machine los
(incl. 1x SA33A) € 119



€ 155

SR1565

SET GLASDRAGERS

Set á 2 stuks, inclusief spanband met ratel, draagkracht tot 70kg



€ 88

SR1619

BLINDKLINKNAGELTANG 6,4MM

Geschikt voor nagels tot 6,4mm kopgrootte (RVS max 5,5mm).
Incl neusstukken 2,4/ 3,2/ 4,0/ 4,8/ 5,5/ 6,4mm.

Extra set bekjes/ binnenwerk meegeleverd voor de kleinere maten.



€ 239

ONDERDELEN

BLINDKLINKNAGELTANG SR1619

LOSSE BEK

SP161904

6x12 tbv SR1619 (per stuk)



€ 11,00

NOSE PIECE

SP161901A

6,4mm (gat Ø tbv trekstift: ± 4,4mm)



€ 7,00

SP161901B

5,5mm (gat Ø tbv trekstift: ± 4,1mm)



€ 7,00

SP161901C

4,8mm (gat Ø tbv trekstift: ± 3,3mm)



€ 7,00

SP161901D

4,0mm (gat Ø tbv trekstift: ± 2,7mm)



€ 7,00

SP161901E

3,2mm (gat Ø tbv trekstift: ± 2,1mm)



€ 7,00

SP161901F

2,4mm (gat Ø tbv trekstift: ± 1,8mm)



€ 7,00

(* foto indicatief)

RUITENSNIJDER MESJES

SA33A

50mm € 16,50



SA38

40mm € 16,50



SA33B

90mm € 31,00



SA39B

25mm € 28,50



SA35

50mm € 16,50



SA39C

40mm € 28,50



SA37

40mm € 16,50



SR1562K

CARROSSERIEZAAG IN KOFFER

Hoogtoerig, 9.000bpm, in koffer met toebehoren; zaagbladen 24 tands/ set á 5 stuks (SA1524SA), zaagbladen 32 tands/ set á 5 stuks (SA1532SA), Orion nippel JWL522312, spangereedschap, klaar voor gebruik.

SR1562 Machine zonder accessoires € 99



€ 109

SR5362K

CARROSSERIEZAAG IN KOFFER

LOW
NOISE/VIBRATION

Hoogtoerig, 9.500bpm, geluidsarm/trillingsvrij, voorzien van swivel, in koffer met toebehoren; zaagbladen 24 tands/ set á 5 stuks (SA1524SA), zaagbladen 32 tands/ set á 5 stuks (SA1532SA), Orion nippel JWL522312, spangereedschap, klaar voor gebruik.

SR5362 Machine zonder accessoires € 199



€ 225

SR5360K

CARROSSERIEZAAG HEAVY DUTY IN KOFFER

LOW
NOISE/VIBRATION

Zeer sterk door relatief laag toerental, 5.000bpm en lange slag, geluidsarm en trillingsvrij, voorzien van swivel, in koffer met toebehoren, incl zaagbladen 18 tands/ set á 5 stuks (SA53618), zaagbladen 24 tands/ set á 5 stuks (SA53624), Orion nippel JWL522312, spangereedschap, klaar voor gebruik.

SR5360 Machine zonder accessoires € 259



€ 295

ZAAGBLADEN

Set zaagbladen (5pcs) voor zaagmachine SR1562(K) + SR5362(K). Bladafmeting H x L = 12 x 95mm

SA1518SA 18 tands, 5 pcs € 9,90
SA1524SA 24 tands, 5 pcs € 9,90
SA1532SA 32 tands, 5 pcs € 9,90



ZAAGBLADEN

Set zaagbladen (5pcs) voor zaagmachine SR5360(K)
Bladafmeting H x L = 12 x 140mm

SA53618 18 tands, 5 pcs € 17,50
SA53624 24 tands, 5 pcs € 17,50



JWL140009

BLAASPISTOOL ULTRALANG MET THRUST NOZZLE

Met dit 1 meter lange blaaspistool wordt het heel eenvoudig moeilijk bereikbare plekken schoon te blazen. Voorzien van een Thrust nozzle waarmee de uitgaande lucht nog eens extra versneld wordt, ideaal om een werkplaatsvloer mee schoon te blazen. Met een soft grip handvat ter bescherming tegen koude en voor gecontroleerd gebruik. Wordt geleverd met een extra nozzle met zijdelingse openingen om cilindrische ruimten schoon te kunnen maken.



€ 65

BLAASPISTOOL GEBOGEN

KUNSTSTOF



JWL140102
25 stuks



JWL140102 Blaaspistool, kort gebogen, Ø6mm € 9,50

JWL140101 Blaaspistool, kort gebogen, Ø8mm € 11,00

JWL140120 Blaaspistool, kort gebogen, Ø8mm RVS € 24,50

JWL140001

BLAASPISTOOL MET THRUST NOZZLE

Voorzien van een Thrust nozzle waarmee de uitgaande lucht nog eens extra versneld wordt.



€ 29,50

BLAASPISTOOL REGELBAAR



JWL140104 Blaaspistool regelbaar Ø6mm € 21,00

JWL140103 Blaaspistool regelbaar Ø8mm € 21,00

BLAASPISTOOL RECHT

KUNSTSTOF, Ø8MM



JWL140100 Blaaspistool, recht 100mm € 13,50

JWL140112 Blaaspistool, recht 300mm € 17,00

JWL140113 Blaaspistool, recht 500mm € 19,00

JWL140114 Blaaspistool, recht 1000mm € 22,00

BLAASPISTOOL MET GELUIDDEMPER

KUNSTSTOF, Ø8MM



JWL140126 Blaaspistool recht € 24,00

JWL140125 Blaaspistool gebogen € 19,00

JWL140135 Blaaspistool gebogen, regelbaar € 26,00

JWL140026

BLAASPISTOOL KORT, BREED NEUSSTUK

Voor snel schoonspuiten van grote oppervlakten.



€ 17,50

JWL140023

BLAASPISTOOL MET RUBBER KOP

Ter voorkoming van beschadigingen aan carrosserie of werkstuk.



€ 12

JWL150120

BANDENPOMP MET MANOMETER

Manometer tot 12 bar



€ 38,50

JWL140022

BLAASPISTOOL MET GEBOGEN TUIT EN RUBBER KOP

Ter voorkoming van beschadiging aan carrosserie of werkstuk.



€ 14,50

JWL150123

BANDENPOMP MET TWINCONNECTOR

Manometer tot 12 bar



€ 55

JWL151120

BANDENPOMP MET SNELKOPPELING

Voorzien van een snelkoppeling; heel eenvoudig met 1 vloeiende beweging luchtdicht op het ventiel te plaatsen en na gebruik weer handig los te koppelen. Manometer tot 12 bar.



€ 39,90

JWL143102 REMONTLUCHTER 1,2 LTR

Met handige ophangbeugel,
slanglengte 1,5mtr,
tankinhoud 1,2ltr.



JWL143205
Rubber nippel

€ 39,90

JWL142185 KOELSYSTEEMSPOELER

Voor het eenvoudig doorspoelen
van het koelsysteem.



€ 45

JWL142135 VLOEISTOFSPUIT

Kunststof nozzle 200mm,
tank inhoud 1,2ltr.
Corrosiebestendig.



€ 35

SR1507 KITSPUIT

Tbv 310ml patronen



€ 32,50

JWL143150 NAVULFLES TBV REMONTLUCHTER

Te gebruiken i.c.m. remontluchter
JWL143102, om automatisch het
remoliereservoir te vullen tijdens
het ontluichten van het remsysteem,
eenvoudig te plaatsen, voorzien van
doseerkraan.



€ 36

SR1520 KITSPUIT 300/400ML

Kitspuit tbv 310ml patronen en 300/400ml worsten. Geheel in aluminium uitgevoerd, perfecte balans door centraal geplaatste handgreep, zowel voor patronen als worsten te gebruiken. Kitaanvoer stopt direct na loslaten aan/uit schakelaar.



€ 175

SR1522 KITSPUIT 300/400/600ML

Kitspuit tbv 310ml patronen en 300/400/600ml worsten. Geheel in aluminium uitgevoerd, perfecte balans door centraal geplaatste handgreep, zowel voor patronen als worsten te gebruiken. Kitaanvoer stopt direct na loslaten aan/uit schakelaar.



€ 195

SR1536

TECTYLSPUIT, REGELBAAR

Geschikt voor zowel bulk producten (beker vullen met vloeistof) als gevulde onderschroef-bekers (deze kunnen direct op de spuit geschroefd worden, daarna dient voor een goede werking ook de (lege) beker gemonteerd te worden).



Incl holleruimteslangen (set á 3 stuks) SA1535H, Ø6x1600mm

€ 208

SA1535H

HOLLERUIMTESLANG, 3DLG

Tbv SR1536; elke slang geeft specifieke verneveling (3 verschillende) Ø6x1600mm



€ 33,50

SR1530

VETSPUIT

Handgreep 360° draaibaar, constante vetstroom, zowel geschikt voor los vet (eenvoudig te vullen via vulnippel) als Ø54/400gr patronen.



€ 145

JWL146100

TECTYLSPUIT, MET BEKER

Corrosiebestendig, tankinhoud 1,2L



Optie:

JWL146110 Holleruimte slang

€ 38,50

JWL146110

HOLLERUIMTE SLANG

Holleruimte slang Ø8x900mm, te monteren op JWL146134/146100/146101.



€ 17,50



JWL146101

TECTYLSPUIT (METAAL)

Voor onderschroef bekers, met metalen aanzuigbuis, corrosiebestendig.



Optie:
JWL146110 Hollaruimte slang

€ 44

JWL146134

TECTYLSPUIT (KUNSTSTOF)

Voor onderschroef bekers, met kunststof aanzuigbuis.



Optie:
JWL146110 Hollaruimte slang

€ 38

JWL145154

SODABLASTER 1,2 LTR

De sodablaste verwijderd verf en oppervlakte roest/verf van ramen en kozijnen/anti aangroei coatings van boten/vernis van meubels/aanslag op mechanische delen, zonder beschadiging van glas/rubber/kunststof/hout. Beschermt metaal tevens tegen roesten na behandelen (in tegenstelling tot zandstralen).



€ 69

JWL320103

SODA, 5L

Tbv sodablaste JWL145154.



€ 22,50

JWL145100

STRAALAPPARAAT 0,75LTR

Incl. hardstalen nozzle (JWL145202)



€ 39,50

PERSLUCHTSLANG

PU/PVC SLANG
voor algemeen gebruik



708810 Ø 10x15mm 10mtr 1/4" draaikoppeling € 27,50
708820 Ø 10x15mm 20mtr 1/4" draaikoppeling € 45,00

PERSLUCHTSLANG

PU/PVC SLANG
voor algemeen gebruik



708850 Ø 10x15mm 50mtr € 95,00
708950 Ø 13x19mm 50mtr € 149,00

SLANG OPHANGBEUGEL

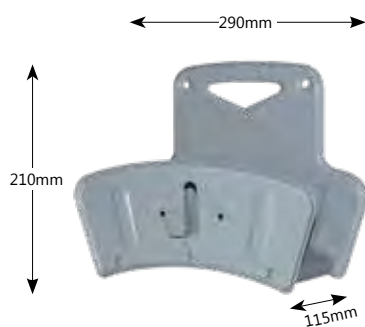

712500 Staal, gecoat € 49,50
712502 RVS uitvoering € 89,50

PERSLUCHTSLANG PU

PU SLANG
knikbestendig, goede
flexibiliteit bij alle
temperaturen, vuilafstotend,
licht in gewicht, bestand
tegen chemicaliën



ST13602 Ø 6,5x10mm 25mtr € 64,00
ST13802 Ø 8x12mm 25mtr € 85,00
ST13102 Ø 10x14mm 25mtr € 99,00
ST13132 Ø 13x18mm 25mtr € 168,00

PERSLUCHTSLANG RUBBER

RUBBER SLANG
bestand tegen lasspetters
en vonken



ST14800 Ø 8x 15mm 50mtr € 119,00
ST14100 Ø 10x 17mm 50mtr € 132,00
ST14130 Ø 13x 21mm 50mtr € 189,00

ST2018

SLANGKLEM ASSORTIMENTSKOFFER, 202DLG.

Met deze 1-oor slangklemmen voorkomt u niet alleen uitwendige, maar vooral ook INWENDIGE beschadigingen aan de slang. Vaak worden (klassieke) slangklemmen te vast aangedraaid; hierdoor drukt de monteur onbewust de binnenzijde van de slang kapot op de nok/ ribbels van de slangnippel. Vervolgens dringt de gecompriëerde lucht zich via de ontstane scheurtjes tussen de binnen- en buitenmantel van de slang, deze zoekt zijn weg vervolgens door de gehele slang met bobbel als gevolg! Met deze klemmen is dat risico verleden tijd; de maximale verkleining van de slangklemdiameter is automatisch de juiste.

Inhoud koffer:

ST2002 Slangklem (1-oor) 9,5-10,9mm RVS, 50x

ST2003 Slangklem (1-oor) 11-12,9mm RVS, 50x

ST2004 Slangklem (1-oor) 13-14,9mm RVS, 50x

ST2005 Slangklem (1-oor) 15-19mm RVS, 50x

ST2015 Slangklemtang, tbv 1-oor slangklemmen



€ 55

PU SPIRAALSLANGEN

Knikbestendig, goede flexibiliteit, ook bij lagere temperaturen, vuilafstotend, licht in gewicht, bestand tegen chemicaliën. Uiteinden zijn gevormd, waardoor bij uittrekken de slang niet knikt, tevens aan 1 zijde voorzien van een draaikoppeling.

PU SLANG

knikbestendig, goede flexibiliteit bij alle temperaturen, vuilafstotend, licht in gewicht, bestand tegen chemicaliën



ST13502A 5x8mm, werklengte 2mtr, 1/4" aansluiting € 25,00

ST13504A 5x8mm, werklengte 4mtr, 1/4" aansluiting € 28,00

ST13506A 5x8mm, werklengte 6mtr, 1/4" aansluiting € 32,00

ST13604A 6,5x10mm, werklengte 4mtr, 1/4" aansluiting € 32,00

ST13606A 6,5x10mm, werklengte 6mtr, 1/4" aansluiting € 39,00

ST13608A 6,5x10mm, werklengte 8mtr, 1/4" aansluiting € 47,00

ST13804A 8x12mm, werklengte 4mtr, 3/8" aansluiting € 42,50

ST13806A 8x12mm, werklengte 6mtr, 3/8" aansluiting € 49,00

ST13808A 8x12mm, werklengte 8mtr, 3/8" aansluiting € 59,00

SLANGKLEMMEN

1-oor slangklemmen, te gebruiken met slangklemtang ST2015, in verschillende diameters leverbaar, geen risico op slangbeschadiging.



ST2002 Slangklem (1-oor) 9,5-10,9mm RVS, 50x € 8,00

ST2003 Slangklem (1-oor) 11-12,9mm RVS, 50x € 8,50

ST2004 Slangklem (1-oor) 13-14,9mm RVS, 50x € 9,00

ST2005 Slangklem (1-oor) 15-19mm RVS, 50x € 12,00

ST2006 Slangklem (1-oor) 19-20,9 mm RVS, 10x € 10,50

ST2007 Slangklem (1-oor) 21-24 mm RVS, 10x € 12,50

ST2015

SLANGKLEMTANG

Slangklemtang, tbv 1-oor slangklemmen



€ 18

ST180812N

SLANGHASPEL, GESLOTEN HUIS

Ø 8 mm

Voorzien van 12m PU slang (8x12mm); knikbestendig, goede flexibiliteit bij alle temperaturen, vuilafstotend, licht in gewicht, bestand tegen olie/ benzine en chemicaliën. Kunststof behuizing. Luchtaansluiting 1/4" (aanvoerslang 1/4").



PU SLANG

knikbestendig, goede flexibiliteit bij alle temperaturen, vuilafstotend, licht in gewicht, bestand tegen chemicaliën

€ 99

ST130818

SLANGHASPEL, OPEN HUIS

Ø 8 mm

Voorzien van 18m PU slang (8x12mm); knikbestendig, goede flexibiliteit bij alle temperaturen, vuilafstotend, licht in gewicht, bestand tegen olie/ benzine en chemicaliën. Metalen constructie (armhoek instelbaar) en kunststof trommel. Luchtaansluiting 1/4" (aanvoerslang 3/8").



PU SLANG

knikbestendig, goede flexibiliteit bij alle temperaturen, vuilafstotend, licht in gewicht, bestand tegen chemicaliën

€ 109

ST190815N

SLANGHASPEL, GESLOTEN HUIS

Ø 10 mm

Voorzien van 15m PU slang (10x13mm); knikbestendig, goede flexibiliteit bij alle temperaturen, vuilafstotend, licht in gewicht, bestand tegen olie/ benzine en chemicaliën. Kunststof behuizing. Luchtaansluiting 3/8" (aanvoerslang 3/8").



PU SLANG

knikbestendig, goede flexibiliteit bij alle temperaturen, vuilafstotend, licht in gewicht, bestand tegen chemicaliën

€ 169

712150

SLANGHASPEL, DRAAGBAAR

Ø 10 mm

Voorzien van 25m PU slang, 10x13mm.



PU SLANG

knikbestendig, goede flexibiliteit bij alle temperaturen, vuilafstotend, licht in gewicht, bestand tegen chemicaliën

€ 186

ST131015

OPEN HASPEL MET 10MM PU SLANG

Ø 10 mm

Metaal, verstelbare armhoek, voorzien van 15m PU slang, 10x14mm, (3/8" aansl).

PU SLANG

knikbestendig, goede flexibiliteit bij alle temperaturen, vuilafstotend, licht in gewicht, bestand tegen chemicaliën



VERSTELBARE ARMHOEK



ST130900 Zwenkbeugel € 22,00

€ 199

ST151015

OPEN HASPEL MET 10MM RUBBER SLANG

Ø 10 mm

Metaal, verstelbare armhoek, voorzien van 15m RUBBER slang, 10x16mm, (3/8" aansl).

RUBBER SLANG

bestand tegen lasspetters en vonken



VERSTELBARE ARMHOEK



ST130900 Zwenkbeugel € 22,00

€ 239

ST131315

OPEN HASPEL MET 13MM PU SLANG

Ø 13 mm

Metaal, verstelbare armhoek, voorzien van 15m PU slang, 13x18mm, (1/2" aansl).

PU SLANG

knikbestendig, goede flexibiliteit bij alle temperaturen, vuilafstotend, licht in gewicht, bestand tegen chemicaliën



VERSTELBARE ARMHOEK



ST130900 Zwenkbeugel € 22,00

€ 219

ST151315

OPEN HASPEL MET 13MM RUBBER SLANG

Ø 13 mm

Metaal, verstelbare armhoek, voorzien van 15m RUBBER slang, 13x20mm, (1/2" aansl).

RUBBER SLANG

bestand tegen lasspetters en vonken



VERSTELBARE ARMHOEK



ST130900 Zwenkbeugel € 22,00

€ 289

HEAVY DUTY SLANGHASPELS

Thermisch verzinkte stalen drum en beugel, voorzien van sterke poedercoating. Uitermate bestendig tegen invloeden van buitenaf en UV. Alle interne componenten (welke direct in verbinding staan met de gecompriëerde lucht), zijn vervaardigd van hoogwaardig composiet materiaal, om corrosie en daardoor lekkage te voorkomen.

HEAVY DUTY SLANGHASPEL MET GESLOTEN HUIS

Slang is vervaardigd van polyurethaan/ thermoplastisch materiaal en extra versterkt met een kunstvezel mantel

Ø 6,5 mm

712005

Slang inw x uitw (mm):	Ø6,5 x10
Slanglengte (mtr):	6
Afgifteslang aansluiting:	1/4"(M)
Aanvoerslang (mm):	Ø6,5 (l=1mtr)
Maximale druk (bar):	20
Gewicht (kg):	3
LxBxH (mm):	275x120x218

€ 158



PU SLANG

knikbestendig, goede flexibiliteit bij alle temperaturen, vuilafstotend, licht in gewicht, bestand tegen chemicaliën

HEAVY DUTY SLANGHASPEL MET GESLOTEN HUIS

Slang is vervaardigd van polyurethaan/ thermoplastisch materiaal en extra versterkt met een kunstvezel mantel

Ø 8 mm

712000

Slang inw x uitw (mm):	Ø8 x12
Slanglengte (mtr):	12
Afgifteslang aansluiting:	1/4"(M)
Aanvoerslang (mm):	Ø8 (l=1mtr)
Maximale druk (bar):	20
Gewicht (kg):	5
LxBxH (mm):	345x160x288

€ 169



PU SLANG

knikbestendig, goede flexibiliteit bij alle temperaturen, vuilafstotend, licht in gewicht, bestand tegen chemicaliën

HEAVY DUTY SLANGHASPELS MET GESLOTEN HUIS

Slang is vervaardigd van polyurethaan/ thermoplastisch materiaal en extra versterkt met een kunstvezel mantel

Ø 8 mm

Ø 10 mm

712001

Slang inw x uitw (mm):	Ø8 x12
Slanglengte (mtr):	15
Afgifteslang aansluiting:	1/4"(M)
Aanvoerslang (mm):	Ø8 (l=1mtr)
Maximale druk (bar):	20
Gewicht (kg):	6
LxBxH (mm):	392x160x324

€ 219

712003

Slang inw x uitw (mm):	Ø10 x14
Slanglengte (mtr):	12
Afgifteslang aansluiting:	3/8"(M)
Aanvoerslang (mm):	Ø10 (l=1mtr)
Maximale druk (bar):	20
Gewicht (kg):	6
LxBxH (mm):	392x160x324

€ 235



PU SLANG

knikbestendig, goede flexibiliteit bij alle temperaturen, vuilafstotend, licht in gewicht, bestand tegen chemicaliën

HEAVY DUTY SLANGHASPELS MET OPEN HUIS

Door de instelbare armhoek en constructie eenvoudig te monteren aan muur/ plafond en vloer. Slang is vervaardigd van hoogwaardig rubber en extra versterkt met een kunstvezel mantel.

RUBBER SLANG
bestand tegen lassetters
en vonken

Ø 8 mm

Ø 10 mm

Ø 13 mm

	712020	712022	712024
Slang inw x uitw (mm):	Ø8 x 14	Ø10 x 17	Ø13 x 20
Slanglengte (mtr):	15	15	15
Afgiftesl. aansluiting:	3/8"(M)	3/8"(M)	1/2"(M)
Aanvoersl.1mtr. aansl. :	3/8"(F)	3/8"(F)	1/2"(M)
Maximale druk (bar):	18	18	18
Gewicht (kg):	20	20	20
LxBxH (mm):	460x413x180	460x413x180	460x413x180

€ 399

€ 415

€ 469

Accessoires

712505 Zwenkbeugel (tbv 712020/..22/..24) **€ 38,00**

712510 Vaste muurbeugel (tbv 712020/..22/..24) **€ 22,50**



HEAVY DUTY SLANGHASPELS MET OPEN HUIS

Door de instelbare armhoek en constructie eenvoudig te monteren aan muur/ plafond en vloer. Slang is vervaardigd van hoogwaardig rubber en extra versterkt met een kunstvezel mantel.

RUBBER SLANG
bestand tegen lassetters
en vonken

Ø 10 mm

Ø 13 mm

Ø 16 mm

	712042	712044	712048
Slang inw x uitw (mm):	Ø10 x 17	Ø13 x 20	Ø16 x 23
Slanglengte (mtr):	25	20	15
Afgifteslang aansluiting:	3/8"(M)	1/2"(M)	1/2"(M)
Aanvoersl.1mtr. aansl. :	3/8"(F)	1/2"(M)	1/2"(M)
Maximale druk (bar):	18	18	18
Gewicht (kg):	25	25	25
LxBxH:	460x413x230mm	460x413x230mm	460x413x230mm

€ 535

€ 585

€ 569

Accessoires

712507 Zwenkbeugel (tbv 712042/..44/..48/..60) **€ 45,00**

712512 Vaste muurbeugel (tbv 712042/..44/..48/..60) **€ 22,50**

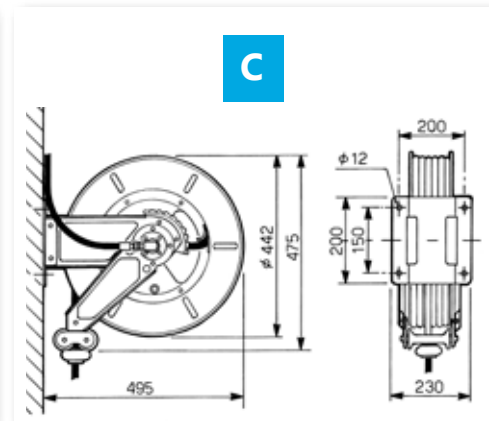
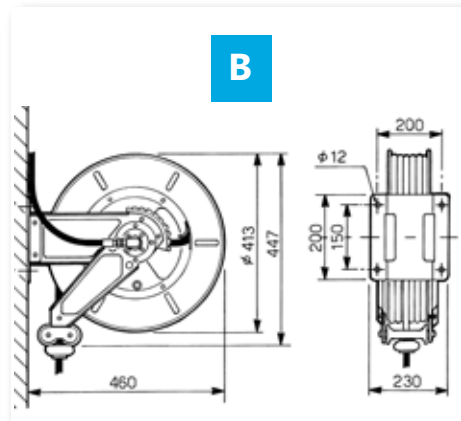
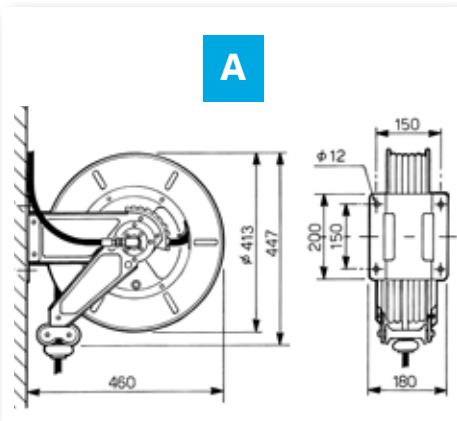

HEAVY DUTY SLANGHASPEL MET OPEN HUIS

Door de instelbare armhoek en constructie eenvoudig te monteren aan muur/ plafond en vloer. Slang is vervaardigd van hoogwaardig rubber en extra versterkt met een kunstvezel mantel.

RUBBER SLANG

bestand tegen lasspeters
en vonken

Ø 19 mm

712060

Slang inw x uitw (mm): **Ø19 x 27**
Slanglengte (mtr): **15**
Afgifteslang aansluiting: **3/4" (F)**
Aanvoerslang (1mtr) aansluiting: **1" (F)**
Maximale druk (bar): **18**
Gewicht (kg): **25**
LxBxH: **495x442x230mm**

€ 749

Accessoires

712507 Zwenkbeugel (tbv 712042/.44/.48/.60) € 45,00

712512 Vaste muurbeugel (tbv 712042/.44/.48/.60) € 22,50



C

RVS HEAVY DUTY SLANGHASPEL MET OPEN HUIS

RVS (AISI 304) drum en beugel, geschikt voor koud en heet water bij lage en hoge druk. De perfecte oplossing voor omgevingen waar resistentie tegen roest, zoals voedingsindustrie, vereist is. Populair in grote keukens, slachthuizen, zuivelindustrie etc. Door de instelbare armhoek en constructie eenvoudig te monteren aan muur/ plafond en vloer. Slang is vervaardigd van hoogwaardig materiaal en extra versterkt met een kunstvezel mantel.

THERMO RUBBER
SLANG

Ø 13 mm

712100

Slang inw x uitw (mm): **Ø13 x 21**
Slanglengte (mtr): **20**
Afgifteslang aansluiting: **1/2" (M)**
Aanvoerslang (1mtr) aansluiting: **1/2" (F)**
Maximale druk: **20bar (25°C), 10bar (70°C)**
Gewicht (kg): **25**
LxBxH: **460x413x230mm**

€ 899

Accessoire

712514 Zwenkbeugel (tbv 712100) € 89



B

ST123020

ELECTROHASPEL 2000W-230V



230V

Voorzien van
20m kabel,
3x1,5mm²



€ 99

ST123040

ELECTROHASPEL 3200W-230V



230V

Voorzien van
15m kabel,
(Heavy Duty),
3x2,5mm²



€ 135

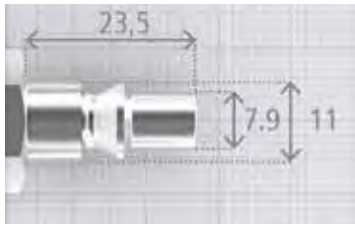

ORION

ORION KOPPELINGEN



- JWL522 002** Orion koppeling 1/4" binnendraad € 9,90
JWL522 004 Orion koppeling 3/8" binnendraad € 9,90
JWL522 005 Orion koppeling 1/2" binnendraad € 9,90



- JWL522 012** Orion koppeling 1/4" buitendraad € 9,90
JWL522 014 Orion koppeling 3/8" buitendraad € 9,90
JWL522 015 Orion koppeling 1/2" buitendraad € 9,90



- JWL522 022** Orion koppeling 6mm slangpilaar € 9,90
JWL522 023 Orion koppeling 8mm slangpilaar € 9,90
JWL522 024 Orion koppeling 10mm slangpilaar € 9,90
JWL522 025 Orion koppeling 13mm slangpilaar € 9,90

ORION KNIKKOPPELINGEN (A)



- 712802** Orion 1/4" binnendr (20500287) € 24,50
712804 Orion 3/8" binnendr (20500288) € 24,50
712805 Orion 1/2" binnendr (20500289) € 24,50



- 712812** Orion 1/4" buitendr (20500294) € 24,50
712814 Orion 3/8" buitendr (20500295) € 24,50
712815 Orion 1/2" buitendr (20500296) € 24,50



- 712822** Orion 6mm slangaansl (20500300) € 24,50
712823 Orion 8mm slangaansl (20500301) € 24,50
712824 Orion 10mm slangaansl (20500302) € 24,50
712825 Orion 13mm slangaansl (20500303) € 24,50

ORION VEILIGHEIDS KOPPELINGEN MET DRUKKNOP



- 712702** Orion veilig kopp ASI-061101 1/4" binnendr. € 32,50
712704 Orion veilig kopp ASI-061102 3/8" binnendr. € 32,50
712705 Orion veilig kopp ASI-061103 1/2" binnendr. € 34,00



- 712712** Orion veilig kopp ASI-061151 1/4" buitendr. € 32,50
712714 Orion veilig kopp ASI-061152 3/8" buitendr. € 32,50
712715 Orion veilig kopp ASI-061153 1/2" buitendr. € 34,00



- 712722** Orion veilig kopp ASI-061806 6mm slangp. € 32,50
712723 Orion veilig kopp ASI-061808 8mm slangp. € 32,50
712724 Orion veilig kopp ASI-061810 10mm slangp. € 32,50
712725 Orion veilig kopp ASI-061813 13mm slangp. € 34,00

ORION NIPPELS



- JWL522 302** Orion nippel 1/4" binnendraad € 2,50
JWL522 304 Orion nippel 3/8" binnendraad € 3,00
JWL522 305 Orion nippel 1/2" binnendraad € 3,50



- JWL522 312** Orion nippel 1/4" buitendraad € 1,95
JWL522 314 Orion nippel 3/8" buitendraad € 2,50
JWL522 315 Orion nippel 1/2" buitendraad € 2,50



- JWL522 322** Orion nippel 6mm slangpilaar € 2,50
JWL522 323 Orion nippel 8mm slangpilaar € 2,50
JWL522 324 Orion nippel 10mm slangpilaar € 2,50
JWL522 325 Orion nippel 13mm slangpilaar € 2,50

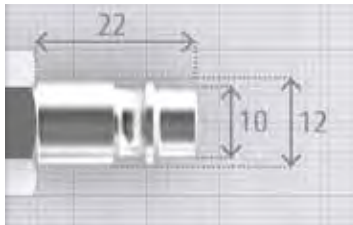

EURO

EURO KOPPELINGEN



- JWL520 002** EURO koppeling 1/4" binnendraad € 9,90
JWL520 004 EURO koppeling 3/8" binnendraad € 9,90
JWL520 005 EURO koppeling 1/2" binnendraad € 11,00



- JWL520 012** EURO koppeling 1/4" buitendraad € 9,90
JWL520 014 EURO koppeling 3/8" buitendraad € 9,90
JWL520 015 EURO koppeling 1/2" buitendraad € 11,00



- JWL520 022** EURO koppeling 6mm slangpilaar € 9,90
JWL520 023 EURO koppeling 8mm slangpilaar € 9,90
JWL520 024 EURO koppeling 10mm slangpilaar € 9,90
JWL520 025 EURO koppeling 13mm slangpilaar € 11,00

EURO KNIKKOPPELINGEN (C)



- 712832** EURO 1/4" binnendr (20500345) € 28,50
712834 EURO 3/8" binnendr (20500346) € 28,50
712835 EURO 1/2" binnendr (20500347) € 28,50



- 712842** EURO 1/4" buitendr (20500351) € 28,50
712844 EURO 3/8" buitendr (20500352) € 28,50
712845 EURO 1/2" buitendr (20500353) € 28,50



- 712853** EURO 8mm slangaansl (20500356) € 28,50
712854 EURO 10mm slangaansl (20500357) € 28,50
712855 EURO 13mm slangaansl (20500358) € 28,50

EURO VEILIGHEIDS KOPPELINGEN MET DRUKKNOP



- 712732** EURO veiligh kopp ESI-071101 1/4" binnendr. € 32,50
712734 EURO veiligh kopp ESI-071102 3/8" binnendr. € 32,50
712735 EURO veiligh kopp ESI-071103 1/2" binnendr. € 34,00



- 712742** EURO veiligh kopp ESI-071151 1/4" buitendr. € 32,50
712744 EURO veiligh kopp ESI-071152 3/8" buitendr. € 32,50
712745 EURO veiligh kopp ESI-071153 1/2" buitendr. € 34,00



- 712752** EURO veiligh kopp ESI-071806 6mm slangp. € 32,50
712753 EURO veiligh kopp ESI-071808 8mm slangp. € 32,50
712754 EURO veiligh kopp ESI-071810 10mm slangp. € 32,50
712755 EURO veiligh kopp ESI-071813 13mm slangp. € 34,00

EURO NIPPELS



- JWL520 302** EURO nippel 1/4" binnendraad € 2,50
JWL520 304 EURO nippel 3/8" binnendraad € 2,50
JWL520 305 EURO nippel 1/2" binnendraad € 3,50



- JWL520 312** EURO nippel 1/4" buitendraad € 1,95
JWL520 314 EURO nippel 3/8" buitendraad € 2,50
JWL520 315 EURO nippel 1/2" buitendraad € 3,50



- JWL520 322** EURO nippel 6mm slangpilaar € 2,50
JWL520 323 EURO nippel 8mm slangpilaar € 2,50
JWL520 324 EURO nippel 10mm slangpilaar € 2,50
JWL520 325 EURO nippel 13mm slangpilaar € 3,50

VERLOOPSTUKKEN

BEIDE ZIJDEN BUITENDRAAD

JWL624 024 1/4" buitendraad x 3/8" buitendraad	€ 2,10
JWL624 025 1/4" buitendraad x 1/2" buitendraad	€ 3,10
JWL624 045 3/8" buitendraad x 1/2" buitendraad	€ 3,00
JWL624 057 1/2" buitendraad x 3/4" buitendraad	€ 4,90



BEIDE ZIJDEN BINNENDRAAD

JWL629 024 1/4" binnendraad x 3/8" binnendraad	€ 2,40
JWL629 045 3/8" binnendraad x 1/2" binnendraad	€ 3,30



BINNENDRAAD X BUITENDRAAD

JWL622 020 1/8" binnendraad x 1/4" buitendraad	€ 1,60
JWL622 022 1/4" binnendraad x 1/4" buitendraad	€ 1,80
JWL622 042 1/4" binnendraad x 3/8" buitendraad	€ 2,20
JWL622 045 1/2" binnendraad x 3/8" buitendraad	€ 3,30
JWL622 024 3/8" binnendraad x 1/4" buitendraad	€ 2,20
JWL622 044 3/8" binnendraad x 3/8" buitendraad	€ 2,20
JWL622 052 1/4" binnendraad x 1/2" buitendraad	€ 2,60
JWL622 054 3/8" binnendraad x 1/2" buitendraad	€ 2,60



KOPPELSTUKKEN

BEIDE ZIJDEN BUITENDRAAD

JWL624 022 Koppelstuk, beide zijden 1/4" buitendraad	€ 1,60
JWL624 044 Koppelstuk, beide zijden 3/8" buitendraad	€ 2,30
JWL624 055 Koppelstuk, beide zijden 1/2" buitendraad	€ 3,10
JWL624 077 Koppelstuk, beide zijden 3/4" buitendraad	€ 5,50



BEIDE ZIJDEN BINNENDRAAD

JWL629 022 Koppelstuk, beide zijden 1/4" binnendraad	€ 1,90
JWL629 044 Koppelstuk, beide zijden 3/8" binnendraad	€ 2,40
JWL629 055 Koppelstuk, beide zijden 1/2" binnendraad	€ 3,40

SLANGPILAREN

JWL625 022 Slangpilaar 6mm, met 1/4" buitendraad	€ 2,40
JWL625 024 Slangpilaar 6mm, met 3/8" buitendraad	€ 2,90
JWL625 025 Slangpilaar 6mm, met 1/2" buitendraad	€ 3,10
JWL625 032 Slangpilaar 8mm, met 1/4" buitendraad	€ 2,10
JWL625 034 Slangpilaar 8mm, met 3/8" buitendraad	€ 2,70
JWL625 035 Slangpilaar 8mm, met 1/2" buitendraad	€ 3,60
JWL625 042 Slangpilaar 10mm, met 1/4" buitendraad	€ 2,10
JWL625 044 Slangpilaar 10mm, met 3/8" buitendraad	€ 2,70
JWL625 045 Slangpilaar 10mm, met 1/2" buitendraad	€ 3,30
JWL625 052 Slangpilaar 13mm, met 1/4" buitendraad	€ 2,80
JWL625 054 Slangpilaar 13mm, met 3/8" buitendraad	€ 4,00
JWL625 055 Slangpilaar 13mm, met 1/2" buitendraad	€ 4,20
JWL625 057 Slangpilaar 13mm, met 3/4" buitendraad	€ 8,20



DRAAIKOPPELINGEN EN REGELAARS

SA2400 Regelaar,
1/4" binnendraad x 1/4" buitendraad € 7,00



SA2420 Draaikoppeling,
1/4" binnendraad x 1/4" buitendraad € 19,90



SA2450 Draaikoppeling met regelaar,
1/4" binnendraad x 1/4" buitendraad € 19,50



Y-STUKKEN

JWL627 022 Y-Stuk 1/4", 3x binnendraad € 3,20
JWL627 044 Y-Stuk 3/8", 3x binnendraad € 4,40
JWL627 055 Y-Stuk 1/2", 3x binnendraad € 7,30



Y-STUKKEN

JWL627 222 Y-Stuk 1/4", 2x binnendraad/ 1x buitendraad € 3,40
JWL627 244 Y-Stuk 3/8", 2x binnendraad/ 1x buitendraad € 4,30
JWL627 255 Y-Stuk 1/2", 2x binnendraad/ 1x buitendraad € 7,80



L-STUKKEN

JWL623 022 L-Stuk 1/4", 2x binnendraad € 3,30
JWL623 044 L-Stuk 3/8", 2x binnendraad € 4,40
JWL623 055 L-Stuk 1/2", 2x binnendraad € 6,50
JWL623 077 L-Stuk 3/4", 2x binnendraad € 9,50



JWL623 122 L-Stuk 1/4", 2x buitendraad € 3,00
JWL623 144 L-Stuk 3/8", 2x buitendraad € 4,20
JWL623 155 L-Stuk 1/2", 2x buitendraad € 6,60



T-STUKKEN

JWL630 022 T-Stuk 1/4", 3x binnendraad € 3,80
JWL630 044 T-Stuk 3/8", 3x binnendraad € 5,80
JWL630 055 T-Stuk 1/2", 3x binnendraad € 7,60
JWL630 077 T-Stuk 3/4", 3x binnendraad € 10,50



T-STUKKEN

JWL630 222 T-Stuk 1/4", 2x binnendraad/ 1x buitendr € 3,90
JWL630 244 T-Stuk 3/8", 2x binnendraad/ 1x buitendr € 5,50
JWL630 255 T-Stuk 1/2", 2x binnendraad/ 1x buitendr € 8,70
JWL630 277 T-Stuk 3/4", 2x binnendraad/ 1x buitendr € 11,90



SLANGVERBINDERS

JWL621 022 Slangverbinder, beide zijden 6mm € 3,80
JWL621 033 Slangverbinder, beide zijden 8mm € 3,80
JWL621 044 Slangverbinder, beide zijden 10mm € 3,90
JWL621 055 Slangverbinder, beide zijden 13mm € 4,30



LUCHTVERZORGINGSUNITS

Compleet met waterafscheider, drukregelaar, manometer en olienevelaar. Manometer aan beide zijden te monteren. P1 maximaal 15 Bar/ P2=0-12 Bar.



- SL14500** 1/4", flow max. 500 l/min € 65,00
- SL13500** 3/8", flow max. 1100 l/min € 87,00
- SL12500** 1/2", flow max. 2500 l/min € 125,00

WATERAFSCHEIDERS MET DRUKREGELAAR

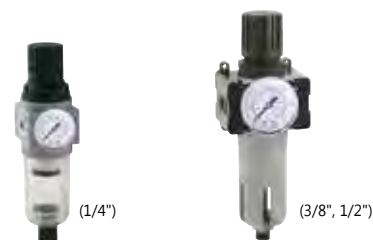

- SL14520** 1/4", flow max. 800 l/min € 41,00
- SL13520** 3/8", flow max. 1650 l/min € 59,00
- SL12520** 1/2", flow max. 3000 l/min € 76,00

WATERAFSCHEIDERS

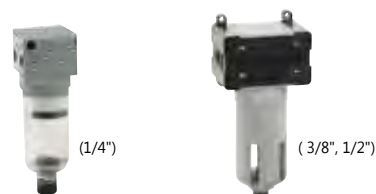

- SL14550** 1/4", flow max. 1000 l/min € 22,00
- SL13550** 3/8", flow max. 1900 l/min € 31,00
- SL12550** 1/2", flow max. 3750 l/min € 45,00



OLIENEVELAARS

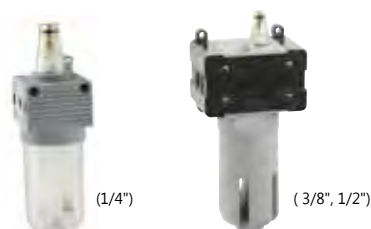

- SL14530** 1/4", flow max. 900 l/min € 28,00
- SL13530** 3/8", flow max. 2600 l/min € 36,00
- SL12530** 1/2", flow max. 5600 l/min € 51,00

DRUKREGELAARS



- SL14540** 1/4", flow max. 900 l/min € 28,00
- SL13540** 3/8", flow max. 2050 l/min € 42,00
- SL12540** 1/2", flow max. 3200 l/min € 59,50

MUURSTEUN

Tbv units met regelknop (onder regelknop te monteren)



- SL15015** tbv 1/4" + 3/8" units € 6
- SL15018** tbv 1/2" units € 7

PERSLUCHTOLIE



- 34681** 500ml € 11,00

1/4" KRACHTDOPPEN

- SK14L08 1/4" Krachtdop, 8mm lang € 5,00
- SK14L09 1/4" Krachtdop, 9mm lang € 5,00
- SK14L10 1/4" Krachtdop, 10mm lang € 5,00
- SK14L11 1/4" Krachtdop, 11mm lang € 5,00
- SK14L12 1/4" Krachtdop, 12mm lang € 5,20
- SK14L13 1/4" Krachtdop, 13mm lang € 5,40
- SK14L14 1/4" Krachtdop, 14mm lang € 5,40



1/4"



Cr-Mo
Chrome
Molybdenum

1/4" HULPSTUKKEN



- SK14E050 1/4" Verlengstuk, 50mm € 4,50
- SK14E100 1/4" Verlengstuk, 100mm € 5,50
- SK14U14 1/4" Kniestuk € 6,20

1/4"



Cr-Mo
Chrome
Molybdenum

SK6908CM

3/8" KRACHTDOPPENSET, 11DLG

Inhoud 8-9-10-11-12-13-14-15-16-17-19mm



Cr-Mo
Chrome
Molybdenum

3/8

€ 26,⁵⁰

3/8"



SK6909CM

3/8" KRACHTDOPPENSET LANG, 11DLG

Inhoud 8-9-10-11-12-13-14-15-16-17-19mm



Cr-Mo
Chrome
Molybdenum

€ 34

3/8"



3/8" KRACHTDOPPEN

- SK38K07 3/8" Krachtdop, 7mm € 4,50
- SK38K08 3/8" Krachtdop, 8mm € 4,50
- SK38K09 3/8" Krachtdop, 9mm € 4,50
- SK38K10 3/8" Krachtdop, 10mm € 4,50
- SK38K11 3/8" Krachtdop, 11mm € 4,50
- SK38K12 3/8" Krachtdop, 12mm € 4,50
- SK38K13 3/8" Krachtdop, 13mm € 4,50
- SK38K14 3/8" Krachtdop, 14mm € 4,50
- SK38K15 3/8" Krachtdop, 15mm € 4,50
- SK38K16 3/8" Krachtdop, 16mm € 4,50
- SK38K17 3/8" Krachtdop, 17mm € 5,00
- SK38K18 3/8" Krachtdop, 18mm € 5,00
- SK38K19 3/8" Krachtdop, 19mm € 5,00
- SK38K20 3/8" Krachtdop, 20mm € 5,00
- SK38K21 3/8" Krachtdop, 21mm € 5,00



Cr-Mo
Chrome
Molybdenum

3/8"



3/8" KRACHTDOPPEN LANG

- SK38L07 3/8" Krachtdop, 7mm lang € 5,00
- SK38L08 3/8" Krachtdop, 8mm lang € 5,00
- SK38L09 3/8" Krachtdop, 9mm lang € 5,00
- SK38L10 3/8" Krachtdop, 10mm lang € 5,00
- SK38L11 3/8" Krachtdop, 11mm lang € 5,00
- SK38L12 3/8" Krachtdop, 12mm lang € 5,00
- SK38L13 3/8" Krachtdop, 13mm lang € 5,00
- SK38L14 3/8" Krachtdop, 14mm lang € 5,00
- SK38L15 3/8" Krachtdop, 15mm lang € 5,00
- SK38L16 3/8" Krachtdop, 16mm lang € 5,00
- SK38L17 3/8" Krachtdop, 17mm lang € 5,60
- SK38L18 3/8" Krachtdop, 18mm lang € 5,60
- SK38L19 3/8" Krachtdop, 19mm lang € 5,60
- SK38L20 3/8" Krachtdop, 20mm lang € 6,20
- SK38L21 3/8" Krachtdop, 21mm lang € 6,20



Cr-Mo
Chrome
Molybdenum

3/8"



3/8" HULPSTUKKEN

- SK38A12 3/8" Adaptor naar 1/2" € 6,20
- SK38E75 3/8" Verlengstuk 75mm € 6,20
- SK38E150 3/8" Verlengstuk 150mm € 7,80
- SK38U38 3/8" Kniestuk € 10,60



3/8"

Cr-Mo
Chrome
Molybdenum

SK6914CM

3/8" SPIRAAL DOPPENSET, 6DLG, UITWENDIG

Ideaal bij het losdraaien van versleten bouten en moeren, ook toe te passen op versleten inbus en torx. Door de linkse draad grijpt de dop zich vast in de versleten bout/ moer en wordt zo gelost. Inhoud 2-3-4-6-8-10mm.



- SK38ST02 2 mm € 6,80
- SK38ST03 3 mm € 6,80
- SK38ST04 4 mm € 6,80
- SK38ST06 6 mm € 6,80
- SK38ST08 8 mm € 7,30
- SK38ST10 10 mm € 7,30



Cr-Mo
Chrome
Molybdenum

€ 34

3/8"

SK6902CM

3/8" SPIRAAL DOPPENSET, 9DLG, INWENDIG

Ideaal bij het losdraaien van versleten bouten en moeren. Door de linkse draad grijpt de dop zich vast in de versleten bout/ moer en wordt zo gelost. Incl. slagstift tbv het verwijderen van de bout of moer uit de dop. Inhoud 10-11-12-13-14-15-16-17-19mm



- SK38SP10 10 mm € 11,00
- SK38SP11 11 mm € 11,00
- SK38SP12 12 mm € 11,00
- SK38SP13 13 mm € 11,00
- SK38SP14 14 mm € 11,80
- SK38SP15 15 mm € 11,80
- SK38SP16 16 mm € 11,80
- SK38SP17 17 mm € 12,50
- SK38SP19 19 mm € 12,50



Cr-Mo
Chrome
Molybdenum

€ 79

3/8"

SK6920CM

1/2" KRACHTDOPPENSET, 5DLG

Inhoud 17-19-21-22-24mm

1/2



Cr-Mo
Chrom
Molybdenum

€ 28

1/2"



SK6925CM

1/2" KRACHTDOPPENSET
LANG, 5DLG

Inhoud 17-19-21-
22-24mm

Cr-Mo
Chrom
Molybdenum

€ 34

1/2"



SK6921CM

1/2" KRACHTDOPPENSET, 12DLG

Inhoud 10-11-12-13-14-15-
16-17-19-21-22-24mm

Cr-Mo
Chrom
Molybdenum

€ 43

1/2"



SK6926CM

1/2" KRACHTDOPPENSET,
LANG, 12DLG

Inhoud 10-11-12-13-14-
15-16-17-19-21-22-24mm

Cr-Mo
Chrom
Molybdenum

€ 66

1/2"



SK6929CM

1/2" KRACHTDOPPENSET, 40DLG

Alle maten in
kort en lang.

Inhoud: 10-11-12-
13-14-15-16-17-18-
19-20-21-22-24-25-
26-27-30-32mm,
kniestuk,
verlengstuk 125mm.

Cr-Mo
Chrom
Molybdenum

€ 99

1/2"



1/2" HULPSTUKKEN

- SK12A34 1/2" Adaptor naar 3/4" € 8,00
- SK12A38 1/2" Adaptor naar 3/8" € 6,50
- SK12E75 1/2" Verlengstuk 75mm € 7,50
- SK12E125 1/2" Verlengstuk 125mm € 8,50
- SK12E250 1/2" Verlengstuk 250mm € 14,00
- SK12U12 1/2" Kniestuk € 12,50



1/2"

Cr-Mo
Chrom
Molybdenum

1/2" KRACHTDOPPEN

- SK12K10 1/2" Krachtdop, 10mm € 5,20
- SK12K11 1/2" Krachtdop, 11mm € 5,20
- SK12K12 1/2" Krachtdop, 12mm € 5,20
- SK12K13 1/2" Krachtdop, 13mm € 5,20
- SK12K14 1/2" Krachtdop, 14mm € 5,70
- SK12K15 1/2" Krachtdop, 15mm € 5,80
- SK12K16 1/2" Krachtdop, 16mm € 5,80
- SK12K17 1/2" Krachtdop, 17mm € 5,80
- SK12K18 1/2" Krachtdop, 18mm € 5,80
- SK12K19 1/2" Krachtdop, 19mm € 5,80
- SK12K20 1/2" Krachtdop, 20mm € 5,80
- SK12K21 1/2" Krachtdop, 21mm € 5,80
- SK12K22 1/2" Krachtdop, 22mm € 6,40
- SK12K23 1/2" Krachtdop, 23mm € 6,40
- SK12K24 1/2" Krachtdop, 24mm € 6,40
- SK12K25 1/2" Krachtdop, 25mm € 7,80
- SK12K26 1/2" Krachtdop, 26mm € 7,80
- SK12K27 1/2" Krachtdop, 27mm € 7,80
- SK12K28 1/2" Krachtdop, 28mm € 9,00
- SK12K29 1/2" Krachtdop, 29mm € 9,00
- SK12K30 1/2" Krachtdop, 30mm € 9,00
- SK12K31 1/2" Krachtdop, 31mm € 9,90
- SK12K32 1/2" Krachtdop, 32mm € 9,90
- SK12K36 1/2" Krachtdop, 36mm € 11,60



Cr-Mo
Chrom
Molybdenum

1/2"



1/2" KRACHTDOPPEN LANG

- SK12L10 1/2" Krachtdop, 10mm lang € 7,50
- SK12L11 1/2" Krachtdop, 11mm lang € 7,50
- SK12L12 1/2" Krachtdop, 12mm lang € 7,50
- SK12L13 1/2" Krachtdop, 13mm lang € 7,50
- SK12L14 1/2" Krachtdop, 14mm lang € 7,50
- SK12L15 1/2" Krachtdop, 15mm lang € 7,50
- SK12L16 1/2" Krachtdop, 16mm lang € 7,50
- SK12L17 1/2" Krachtdop, 17mm lang € 8,00
- SK12L18 1/2" Krachtdop, 18mm lang € 8,00
- SK12L19 1/2" Krachtdop, 19mm lang € 8,00
- SK12L20 1/2" Krachtdop, 20mm lang € 8,00
- SK12L21 1/2" Krachtdop, 21mm lang € 9,00
- SK12L22 1/2" Krachtdop, 22mm lang € 9,00
- SK12L23 1/2" Krachtdop, 23mm lang € 9,50
- SK12L24 1/2" Krachtdop, 24mm lang € 9,50
- SK12L25 1/2" Krachtdop, 25mm lang € 9,90
- SK12L26 1/2" Krachtdop, 26mm lang € 9,90
- SK12L27 1/2" Krachtdop, 27mm lang € 9,90
- SK12L28 1/2" Krachtdop, 28mm lang € 11,80
- SK12L29 1/2" Krachtdop, 29mm lang € 11,80
- SK12L30 1/2" Krachtdop, 30mm lang € 11,80
- SK12L31 1/2" Krachtdop, 31mm lang € 13,40
- SK12L32 1/2" Krachtdop, 32mm lang € 13,40
- SK12L33 1/2" Krachtdop, 33mm lang € 13,90
- SK12L35 1/2" Krachtdop, 35mm lang € 14,90
- SK12L36 1/2" Krachtdop, 36mm lang € 14,90



Cr-Mo
Chrom
Molybdenum

1/2"



SK6927CM

1/2" KRACHTDOPPENSET LANG, 12-KANT, 4DLG



Inhoud
27-30-32-36mm

1/2"



Cr-Mo
Chrome
Molybdenum

€ 33

SK6928CM

1/2" KRACHTDOPPENSET LANG, 12-KANT, 12DLG



Inhoud
10-11-12-13-14-15-16-
17-19-21-22-24mm

1/2"



Cr-Mo
Chrome
Molybdenum

€ 78

SK6903CM

1/2" KRACHTDOPPENSET, 3DLG

Voorzien van kunststof beschermhuls ter bescherming van aluminium velgen.



Inhoud
17-19-21mm

1/2"



Cr-Mo
Chrome
Molybdenum

€ 24

1/2" KRACHTDOPPEN LANG DUNWANDIG

Voorzien van kunststof beschermhuls ter bescherming van aluminium velgen.



1/2"



Cr-Mo
Chrome
Molybdenum

- SK12LD15 15mm (l.groen) € 10,50
- SK12LD17 17mm (blauw) € 10,50
- SK12LD19 19mm (geel) € 10,50
- SK12LD21 21mm (rood) € 10,50
- SK12LD22 22mm (groen) € 10,50

1/2" KRACHTDOPPEN LANG 12-KANT

1/2"



Cr-Mo
Chrome
Molybdenum

- SK12LC10 1/2" Krachtdop 10mm lang 12-kant € 7,50
- SK12LC11 1/2" Krachtdop 11mm lang 12-kant € 7,50
- SK12LC12 1/2" Krachtdop 12mm lang 12-kant € 7,50
- SK12LC13 1/2" Krachtdop 13mm lang 12-kant € 7,50
- SK12LC14 1/2" Krachtdop 14mm lang 12-kant € 7,50
- SK12LC15 1/2" Krachtdop 15mm lang 12-kant € 7,50
- SK12LC16 1/2" Krachtdop 16mm lang 12-kant € 7,50
- SK12LC17 1/2" Krachtdop 17mm lang 12-kant € 8,00
- SK12LC19 1/2" Krachtdop 19mm lang 12-kant € 8,00
- SK12LC21 1/2" Krachtdop 21mm lang 12-kant € 9,00
- SK12LC22 1/2" Krachtdop 22mm lang 12-kant € 9,00
- SK12LC24 1/2" Krachtdop 24mm lang 12-kant € 9,50
- SK12LC27 1/2" Krachtdop 27mm lang 12-kant € 10,50
- SK12LC30 1/2" Krachtdop 30mm lang 12-kant € 11,80
- SK12LC32 1/2" Krachtdop 32mm lang 12-kant € 12,80
- SK12LC36 1/2" Krachtdop 36mm lang 12-kant € 14,90



SK6907CM

1/2" KRACHTDOPPENSET, 5DLG

Voorzien van kunststof beschermhuls ter bescherming van aluminium velgen.



Inhoud
15-17-19-21-22mm

1/2"



Cr-Mo
Chrome
Molybdenum

€ 37

SK12T171921

1/2" TORSIESTAVEN SET

Voor het met het juiste moment aandraaien van bouten en moeren (110Nm) Inhoud 17, 19, 21mm. Tevens los leverbaar.



- SK12T17 17mm (rood) € 22,00
- SK12T19 19mm (blauw) € 22,00
- SK12T21 21mm (bruin) € 22,00

1/2"



Cr-Mo
Chrome
Molybdenum

€ 69

SK6930CM

1/2" KRACHTDOPPENSET TORX, 8DLG

Inhoud T25, T27, T30, T40, T45, T50, T55, T60.

1/2"



Cr-Mo
Chrome
Molybdenum



€49,⁵⁰

SK6932CM

1/2" KRACHTDOPPENSET INBUS, 8DLG

Inhoud H6, H7, H8, H10, H12, H14, H17, H19.

1/2"



Cr-Mo
Chrome
Molybdenum



€49,⁵⁰

1/2" KRACHTDOPPEN TORX

1/2"



Cr-Mo
Chrome
Molybdenum

- SK12T25 1/2" Krachtdop Torx 25 € 9,00
- SK12T27 1/2" Krachtdop Torx 27 € 9,00
- SK12T30 1/2" Krachtdop Torx 30 € 9,00
- SK12T40 1/2" Krachtdop Torx 40 € 9,00
- SK12T45 1/2" Krachtdop Torx 45 € 9,00
- SK12T50 1/2" Krachtdop Torx 50 € 9,00
- SK12T55 1/2" Krachtdop Torx 55 € 9,00
- SK12T60 1/2" Krachtdop Torx 60 € 9,00



1/2" KRACHTDOPPEN INBUS

1/2"



Cr-Mo
Chrome
Molybdenum

- SK12H06 1/2" Krachtdop inbus 6 € 9,00
- SK12H07 1/2" Krachtdop inbus 7 € 9,00
- SK12H08 1/2" Krachtdop inbus 8 € 9,00
- SK12H10 1/2" Krachtdop inbus 10 € 9,00
- SK12H12 1/2" Krachtdop inbus 12 € 9,00
- SK12H14 1/2" Krachtdop inbus 14 € 9,00
- SK12H17 1/2" Krachtdop inbus 17 € 9,00
- SK12H19 1/2" Krachtdop inbus 19 € 9,50



SK6915CM

1/2" SPIRAAL DOPPENSET, 5DLG, UITWENDIG

Ideaal bij het losdraaien van versleten bouten en moeren, ook toe te passen op versleten inbus en torx. Door de linkse draad grijpt de dop zich vast in de versleten bout/ moer en wordt zo gelost.

Inhoud 8-10-12-14-16mm



- SK12ST08 8 mm € 8,50
- SK12ST10 10 mm € 8,50
- SK12ST12 12 mm € 8,50
- SK12ST14 14 mm € 9,50
- SK12ST16 16 mm € 9,50



Cr-Mo
Chrome
Molybdenum

€34

SK6904CM

1/2" SPIRAAL DOPPENSET, 4DLG, INWENDIG

Ideaal bij het losdraaien van versleten bouten en moeren. Door de linkse draad grijpt de dop zich vast in de versleten bout/ moer en wordt zo gelost. Incl slagstift tbv het verwijderen van de bout of moer uit de dop.

Inhoud 17-19-21-22mm.



- SK12SP17 17 mm € 13,80
- SK12SP19 19 mm € 13,80
- SK12SP21 21 mm € 13,80
- SK12SP22 22 mm € 13,80



Cr-Mo
Chrome
Molybdenum

€55

SK6940CM 3/4" KRACHTDOPPENSET

22-24-27-30-32mm

3/4"



Cr-Mo
Chrom
Molybdenum



€ 51

SK6945CM 3/4" KRACHTDOPPENSET LANG

22-24-27-30-32mm

3/4"



Cr-Mo
Chrom
Molybdenum



€ 84

3/4" KRACHTDOPPEN

3/4"



Cr-Mo
Chrom
Molybdenum

SK34K17	3/4" Krachtdop, 17mm	€ 12,50
SK34K18	3/4" Krachtdop, 18mm	€ 12,50
SK34K19	3/4" Krachtdop, 19mm	€ 12,50
SK34K20	3/4" Krachtdop, 20mm	€ 12,50
SK34K21	3/4" Krachtdop, 21mm	€ 12,50
SK34K22	3/4" Krachtdop, 22mm	€ 12,50
SK34K23	3/4" Krachtdop, 23mm	€ 12,50
SK34K24	3/4" Krachtdop, 24mm	€ 12,50
SK34K25	3/4" Krachtdop, 25mm	€ 12,50
SK34K26	3/4" Krachtdop, 26mm	€ 12,50
SK34K27	3/4" Krachtdop, 27mm	€ 12,50
SK34K28	3/4" Krachtdop, 28mm	€ 12,50
SK34K29	3/4" Krachtdop, 29mm	€ 13,50
SK34K30	3/4" Krachtdop, 30mm	€ 13,50
SK34K31	3/4" Krachtdop, 31mm	€ 13,50
SK34K32	3/4" Krachtdop, 32mm	€ 13,50
SK34K33	3/4" Krachtdop, 33mm	€ 13,50
SK34K34	3/4" Krachtdop, 34mm	€ 13,50
SK34K35	3/4" Krachtdop, 35mm	€ 15,00
SK34K36	3/4" Krachtdop, 36mm	€ 15,00
SK34K37	3/4" Krachtdop, 37mm	€ 15,00
SK34K38	3/4" Krachtdop, 38mm	€ 15,00
SK34K40	3/4" Krachtdop, 40mm	€ 18,00
SK34K41	3/4" Krachtdop, 41mm	€ 18,00
SK34K43	3/4" Krachtdop, 43mm	€ 19,50
SK34K44	3/4" Krachtdop, 44mm	€ 21,00
SK34K46	3/4" Krachtdop, 46mm	€ 22,50
SK34K50	3/4" Krachtdop, 50mm	€ 25,00



3/4" KRACHTDOPPEN LANG

3/4"



Cr-Mo
Chrom
Molybdenum

SK34L17	3/4" Krachtdop, 17mm lang	€ 19,50
SK34L18	3/4" Krachtdop, 18mm lang	€ 19,50
SK34L19	3/4" Krachtdop, 19mm lang	€ 19,50
SK34L20	3/4" Krachtdop, 20mm lang	€ 19,50
SK34L21	3/4" Krachtdop, 21mm lang	€ 19,50
SK34L22	3/4" Krachtdop, 22mm lang	€ 19,50
SK34L23	3/4" Krachtdop, 23mm lang	€ 19,50
SK34L24	3/4" Krachtdop, 24mm lang	€ 19,50
SK34L25	3/4" Krachtdop, 25mm lang	€ 19,50
SK34L26	3/4" Krachtdop, 26mm lang	€ 19,50
SK34L27	3/4" Krachtdop, 27mm lang	€ 19,50
SK34L28	3/4" Krachtdop, 28mm lang	€ 19,50
SK34L29	3/4" Krachtdop, 29mm lang	€ 19,50
SK34L30	3/4" Krachtdop, 30mm lang	€ 20,50
SK34L31	3/4" Krachtdop, 31mm lang	€ 20,50
SK34L32	3/4" Krachtdop, 32mm lang	€ 20,50
SK34L33	3/4" Krachtdop, 33mm lang	€ 20,50
SK34L34	3/4" Krachtdop, 34mm lang	€ 20,50
SK34L35	3/4" Krachtdop, 35mm lang	€ 20,50
SK34L36	3/4" Krachtdop, 36mm lang	€ 20,50
SK34L37	3/4" Krachtdop, 37mm lang	€ 25,00
SK34L38	3/4" Krachtdop, 38mm lang	€ 25,00
SK34L40	3/4" Krachtdop, 40mm lang	€ 26,00
SK34L41	3/4" Krachtdop, 41mm lang	€ 28,50
SK34L42	3/4" Krachtdop, 42mm lang	€ 32,00
SK34L43	3/4" Krachtdop, 43mm lang	€ 32,00
SK34L44	3/4" Krachtdop, 44mm lang	€ 32,50
SK34L46	3/4" Krachtdop, 46mm lang	€ 32,50
SK34L50	3/4" Krachtdop, 50mm lang	€ 36,00



3/4" HULPSTUKKEN

3/4"

Cr-Mo
Chrom
Molybdenum



SK34A12	3/4" Adaptor naar 1/2"	€ 14,00
SK34A10	3/4" Adaptor naar 1"	€ 16,00
SK34E100	3/4" Verlengstuk 100mm	€ 18,00
SK34E150	3/4" Verlengstuk 150mm	€ 23,00
SK34E200	3/4" Verlengstuk 200mm	€ 25,00
SK34E250	3/4" Verlengstuk 250mm	€ 27,00
SK34U34	3/4" Kniestuk	€ 38,50

BORGPEN MET O-RING

Voor het borgen van de krachtdop.

3/4"

1"

Cr-Mo
Chrom
Molybdenum



SK34Y10	tbv 3/4" krachtdop 17-48mm	€ 2,90
SK34Y12	tbv 3/4" krachtdop 50-70mm	€ 4,00
SK10Y10	tbv 1" krachtdop 17-70mm	€ 4,50
SK10Y12	tbv 1" krachtdop 71-95mm	€ 5,00

SK6960CM

1" KRACHTDOPPENSET

27-30-32-36mm



1"



Cr-Mo
Chrome
Molybdenum

€ 79

SK6965CM

1" KRACHTDOPPENSET, LANG

27-30-32-36mm



1"



Cr-Mo
Chrome
Molybdenum

€ 98

1" KRACHTDOPPEN

SK10K17	1" Krachtdop, 17mm	€ 19,80
SK10K19	1" Krachtdop, 19mm	€ 19,80
SK10K21	1" Krachtdop, 21mm	€ 19,80
SK10K22	1" Krachtdop, 22mm	€ 19,80
SK10K23	1" Krachtdop, 23mm	€ 19,80
SK10K24	1" Krachtdop, 24mm	€ 19,80
SK10K25	1" Krachtdop, 25mm	€ 19,80
SK10K26	1" Krachtdop, 26mm	€ 19,80
SK10K27	1" Krachtdop, 27mm	€ 19,80
SK10K28	1" Krachtdop, 28mm	€ 19,80
SK10K29	1" Krachtdop, 29mm	€ 19,80
SK10K30	1" Krachtdop, 30mm	€ 19,80
SK10K31	1" Krachtdop, 31mm	€ 19,80
SK10K32	1" Krachtdop, 32mm	€ 19,80
SK10K33	1" Krachtdop, 33mm	€ 22,00
SK10K34	1" Krachtdop, 34mm	€ 22,00
SK10K35	1" Krachtdop, 35mm	€ 22,00
SK10K36	1" Krachtdop, 36mm	€ 22,00
SK10K37	1" Krachtdop, 37mm	€ 22,00
SK10K38	1" Krachtdop, 38mm	€ 22,00
SK10K39	1" Krachtdop, 39mm	€ 23,50
SK10K40	1" Krachtdop, 40mm	€ 23,50
SK10K41	1" Krachtdop, 41mm	€ 26,00
SK10K42	1" Krachtdop, 42mm	€ 26,00
SK10K43	1" Krachtdop, 43mm	€ 29,00
SK10K44	1" Krachtdop, 44mm	€ 29,00
SK10K46	1" Krachtdop, 46mm	€ 29,00
SK10K50	1" Krachtdop, 50mm	€ 33,00
SK10K55	1" Krachtdop, 55mm	€ 37,50
SK10K60	1" Krachtdop, 60mm	€ 43,50
SK10K65	1" Krachtdop, 65mm	€ 48,00
SK10K70	1" Krachtdop, 70mm	€ 62,00
SK10K75	1" Krachtdop, 75mm	€ 72,00
SK10K80	1" Krachtdop, 80mm	€ 84,00
SK10K85	1" Krachtdop, 85mm	€ 94,00
SK10K90	1" Krachtdop, 90mm	€ 108,00
SK10K95	1" Krachtdop, 95mm	€ 138,00
SK10K100	1" Krachtdop, 100mm	€ 175,00
SK10K105	1" Krachtdop, 105mm	€ 189,00



1"



Cr-Mo
Chrome
Molybdenum

1" KRACHTDOPPEN LANG

SK10L17	1" Krachtdop, 17mm lang	€ 28,50
SK10L19	1" Krachtdop, 19mm lang	€ 28,50
SK10L21	1" Krachtdop, 21mm lang	€ 28,50
SK10L22	1" Krachtdop, 22mm lang	€ 28,50
SK10L23	1" Krachtdop, 23mm lang	€ 28,50
SK10L24	1" Krachtdop, 24mm lang	€ 28,50
SK10L25	1" Krachtdop, 25mm lang	€ 28,50
SK10L26	1" Krachtdop, 26mm lang	€ 28,50
SK10L27	1" Krachtdop, 27mm lang	€ 28,50
SK10L28	1" Krachtdop, 28mm lang	€ 29,50
SK10L29	1" Krachtdop, 29mm lang	€ 29,50
SK10L30	1" Krachtdop, 30mm lang	€ 29,50
SK10L31	1" Krachtdop, 31mm lang	€ 29,50
SK10L32	1" Krachtdop, 32mm lang	€ 29,50
SK10L33	1" Krachtdop, 33mm lang	€ 31,00
SK10L34	1" Krachtdop, 34mm lang	€ 31,00
SK10L35	1" Krachtdop, 35mm lang	€ 31,00
SK10L36	1" Krachtdop, 36mm lang	€ 31,00
SK10L37	1" Krachtdop, 37mm lang	€ 32,00
SK10L38	1" Krachtdop, 38mm lang	€ 32,00
SK10L39	1" Krachtdop, 39mm lang	€ 33,00
SK10L40	1" Krachtdop, 40mm lang	€ 33,00
SK10L41	1" Krachtdop, 41mm lang	€ 33,00
SK10L42	1" Krachtdop, 42mm lang	€ 35,00
SK10L43	1" Krachtdop, 43mm lang	€ 35,00
SK10L46	1" Krachtdop, 46mm lang	€ 37,00
SK10L50	1" Krachtdop, 50mm lang	€ 44,00
SK10L55	1" Krachtdop, 55mm lang	€ 52,00
SK10L60	1" Krachtdop, 60mm lang	€ 59,00
SK10L65	1" Krachtdop, 65mm lang	€ 68,00
SK10L70	1" Krachtdop, 70mm lang	€ 79,00
SK10L75	1" Krachtdop, 75mm lang	€ 96,00
SK10L80	1" Krachtdop, 80mm lang	€ 105,00
SK10L85	1" Krachtdop, 85mm lang	€ 122,00
SK10L90	1" Krachtdop, 90mm lang	€ 143,00



1"



Cr-Mo
Chrome
Molybdenum

1" VERLENGSTUKKEN



SK10E100	1" Verlengstuk 100mm	€ 32,00
SK10E150	1" Verlengstuk 150mm	€ 35,00
SK10E200	1" Verlengstuk 200mm	€ 55,00
SK10E250	1" Verlengstuk 250mm	€ 60,00

1"

Cr-Mo
Chrome
Molybdenum

1" HULPSTUKKEN



SK10A34	1" Adaptor naar 3/4"	€ 22,00
SK10A112	1" Adaptor naar 1,5"	€ 33,00



SK10U10	1" Kniestuk	€ 64,00
---------	-------------	---------

1"

Cr-Mo
Chrome
Molybdenum

730002

SPIRAALBORENSSET T/M 10MM, 19DLG

HSS-G geslepen boren, DIN338, cilindrisch, kruisaanslijping volgens DIN1412 C, tophoek 118°.

Voor algemene toepassingen als staal en gietijzer.

Hoge nauwkeurigheid en perfecte centrering.

Inhoud: 1/ 1,5/ 2/ 2,5/ 3/ 3,5/ 4/ 4,5/ 5/ 5,5/ 6/ 6,5/ 7/ 7,5/ 8/ 8,5/ 9/ 9,5/ 10mm



€ 23,50

730004

SPIRAALBORENSSET T/M 13MM, 25DLG

HSS-G geslepen boren, DIN338, cilindrisch, kruisaanslijping volgens DIN1412 C, tophoek 118°.

Voor algemene toepassingen als staal en gietijzer. Hoge nauwkeurigheid en perfecte centrering.

Inhoud: 1/ 1,5/ 2/ 2,5/ 3/ 3,5/ 4/ 4,5/ 5/ 5,5/ 6/ 6,5/ 7/ 7,5/ 8/ 8,5/ 9/ 9,5/ 10/ 10,5/ 11/ 11,5/ 12/ 12,5/ 13



€ 44

731002

COBALT SPIRAALBORENSSET COBALT T/M 10MM, 19DLG

HSS-E (CO 5) Cobalt gelegeerd (5%), DIN338, cilindrisch, kruisaanslijping volgens DIN1412 C, tophoek 135°.

Voor algemene toepassingen en RVS (V2A- V4A). Hoge nauwkeurigheid en perfecte centrering.

Inhoud: 1/ 1,5/ 2/ 2,5/ 3/ 3,5/ 4/ 4,5/ 5/ 5,5/ 6/ 6,5/ 7/ 7,5/ 8/ 8,5/ 9/ 9,5/ 10mm



€ 46

731004

COBALT SPIRAALBORENSSET COBALT T/M 13MM, 25DLG

HSS-E (CO 5) Cobalt gelegeerd (5%), DIN338, cilindrisch, kruisaanslijping volgens DIN1412 C, tophoek 135°.

Voor algemene toepassingen en RVS (V2A- V4A). Hoge nauwkeurigheid en perfecte centrering.

Inhoud: 1/ 1,5/ 2/ 2,5/ 3/ 3,5/ 4/ 4,5/ 5/ 5,5/ 6/ 6,5/ 7/ 7,5/ 8/ 8,5/ 9/ 9,5/ 10/ 10,5/ 11/ 11,5/ 12/ 12,5/ 13



€ 89,90

SPIRAALBOREN

HSS-G geslepen boren, DIN338, cilindrisch, kruisaanslijping volgens DIN1412 C, tophoek 118°. Voor algemene toepassingen als staal en gietijzer. Hoge nauwkeurigheid en perfecte centrering.

730010	Spiraalboor 1,0mm (10x)	€ 3,40
730015	Spiraalboor 1,5mm (10x)	€ 3,40
730020	Spiraalboor 2,0mm (10x)	€ 3,50
730025	Spiraalboor 2,5mm (10x)	€ 3,70
730030	Spiraalboor 3,0mm (10x)	€ 3,90
730033	Spiraalboor 3,3mm (10x)	€ 4,60
730035	Spiraalboor 3,5mm (10x)	€ 4,10
730040	Spiraalboor 4,0mm (10x)	€ 5,80
730042	Spiraalboor 4,2mm (10x)	€ 5,70
730045	Spiraalboor 4,5mm (10x)	€ 7,30
730050	Spiraalboor 5,0mm (10x)	€ 8,60
730055	Spiraalboor 5,5mm (10x)	€ 9,50
730060	Spiraalboor 6,0mm (10x)	€ 11,20
730065	Spiraalboor 6,5mm (10x)	€ 12,20
730068	Spiraalboor 6,8mm (10x)	€ 14,80
730070	Spiraalboor 7,0mm (10x)	€ 14,80
730075	Spiraalboor 7,5mm (10x)	€ 17,10
730080	Spiraalboor 8,0mm (10x)	€ 20,90
730085	Spiraalboor 8,5mm (10x)	€ 21,80
730090	Spiraalboor 9,0mm (10x)	€ 24,50
730095	Spiraalboor 9,5mm (10x)	€ 27,00
730100	Spiraalboor 10,0mm (10x)	€ 30,50
730102	Spiraalboor 10,2mm (5x)	€ 18,20
730105	Spiraalboor 10,5mm (5x)	€ 15,90
730110	Spiraalboor 11,0mm (5x)	€ 17,70
730115	Spiraalboor 11,5mm (5x)	€ 19,00
730120	Spiraalboor 12,0mm (5x)	€ 21,90
730125	Spiraalboor 12,5mm (5x)	€ 22,60
730130	Spiraalboor 13,0mm (5x)	€ 26,00



COBALT SPIRAALBOREN COBALT

HSS-E (CO 5) Cobalt gelegeerd (5%), DIN338, cilindrisch, kruisaanslijping volgens DIN1412 C, tophoek 135°. Voor algemene toepassingen en RVS (V2A- V4A). Hoge nauwkeurigheid en perfecte centrering.

731010	Spiraalboor-cobalt 1,0mm (10x)	€ 4,60
731015	Spiraalboor-cobalt 1,5mm (10x)	€ 4,70
731020	Spiraalboor-cobalt 2,0mm (10x)	€ 5,20
731025	Spiraalboor-cobalt 2,5mm (10x)	€ 6,20
731030	Spiraalboor-cobalt 3,0mm (10x)	€ 9,90
731033	Spiraalboor-cobalt 3,3mm (10x)	€ 12,00
731035	Spiraalboor-cobalt 3,5mm (10x)	€ 12,00
731040	Spiraalboor-cobalt 4,0mm (10x)	€ 12,50
731042	Spiraalboor-cobalt 4,2mm (10x)	€ 14,60
731045	Spiraalboor-cobalt 4,5mm (10x)	€ 14,60
731050	Spiraalboor-cobalt 5,0mm (10x)	€ 17,70
731055	Spiraalboor-cobalt 5,5mm (10x)	€ 19,00
731060	Spiraalboor-cobalt 6,0mm (10x)	€ 21,80
731065	Spiraalboor-cobalt 6,5mm (10x)	€ 24,20
731068	Spiraalboor-cobalt 6,8mm (10x)	€ 28,50
731070	Spiraalboor-cobalt 7,0mm (10x)	€ 29,00
731075	Spiraalboor-cobalt 7,5mm (10x)	€ 34,00
731080	Spiraalboor-cobalt 8,0mm (10x)	€ 43,00
731085	Spiraalboor-cobalt 8,5mm (10x)	€ 46,00
731090	Spiraalboor-cobalt 9,0mm (10x)	€ 51,00
731095	Spiraalboor-cobalt 9,5mm (10x)	€ 55,50
731100	Spiraalboor-cobalt 10,0mm (10x)	€ 66,00
731102	Spiraalboor-cobalt 10,2mm (5x)	€ 36,00
731105	Spiraalboor-cobalt 10,5mm (5x)	€ 36,00
731110	Spiraalboor-cobalt 11,0mm (5x)	€ 39,00
731115	Spiraalboor-cobalt 11,5mm (5x)	€ 42,00
731120	Spiraalboor-cobalt 12,0mm (5x)	€ 48,50
731125	Spiraalboor-cobalt 12,5mm (5x)	€ 48,00
731130	Spiraalboor-cobalt 13,0mm (5x)	€ 56,00



730006

SPIRAALBORENSSET T/M 10MM, 170DLG

HSS-G geslepen boren, DIN338, cilindrisch, kruisaanslijping volgens DIN1412 C, tophoek 118°.

Voor algemene toepassingen als staal en gietijzer.

Hoge nauwkeurigheid en perfecte centrering.

Inhoud: 1/ 1,5/ 2/ 2,5/ 3/ 3,5/ 4/ 4,5/ 5/ 5,5/ 6/ 6,5/ 7/ 7,5/ 8/ 8,5/ 9/ 9,5/ 10mm. Verdeling: 10 stuks van elke boor t/m 8mm, 5 stuks vanaf 8,5mm (in metalen koffer).



€ 145

LANGE BOREN

HSS-G geslepen boren, DIN340, cilindrisch, kruisaanslijping volgens DIN1412 C, tophoek 118°. Voor algemene toepassingen als staal en gietijzer. Hoge nauwkeurigheid en perfecte centrering.



732030	Spiraalboor lang (l=100mm) 3,0 mm (10x)	€ 9,00
732033	Spiraalboor lang (l=106mm) 3,3 mm (10x)	€ 10,50
732035	Spiraalboor lang (l=112mm) 3,5 mm (10x)	€ 10,50
732040	Spiraalboor lang (l=119mm) 4,0 mm (10x)	€ 13,00
732042	Spiraalboor lang (l=119mm) 4,2 mm (10x)	€ 16,00
732045	Spiraalboor lang (l=126mm) 4,5 mm (10x)	€ 16,00
732050	Spiraalboor lang (l=132mm) 5,0 mm (10x)	€ 19,00
732055	Spiraalboor lang (l=139mm) 5,5 mm (10x)	€ 22,00
732060	Spiraalboor lang (l=139mm) 6,0 mm (10x)	€ 26,00
732065	Spiraalboor lang (l=148mm) 6,5 mm (10x)	€ 28,00
732068	Spiraalboor lang (l=156mm) 6,8 mm (10x)	€ 35,00
732070	Spiraalboor lang (l=156mm) 7,0 mm (10x)	€ 31,00
732075	Spiraalboor lang (l=156mm) 7,5 mm (10x)	€ 35,00
732080	Spiraalboor lang (l=165mm) 8,0 mm (10x)	€ 40,00
732085	Spiraalboor lang (l=165mm) 8,5 mm (10x)	€ 44,00
732090	Spiraalboor lang (l=175mm) 9,0 mm (10x)	€ 46,00
732095	Spiraalboor lang (l=175mm) 9,5 mm (10x)	€ 49,00
732100	Spiraalboor lang (l=184mm) 10 mm (10x)	€ 58,00

PUNTLASBOREN

TBV SR1568

734830 8mm HSS (44mm) € 10,00



734834 8mm HSS-E TiALN (44mm) € 27,00



PUNTLASBOREN OVERIG

734802 6mm HSS (66mm) € 7,00



734806 8mm HSS (79mm) € 9,00



734810 8mm HSS-E (79mm) € 19,50
TiALN



734818 10mm HSS (72mm) € 17,00



734182

TRAPPENBORENSSET 3DLG

HSS, voor het boren van grotere gaten in dun materiaal zoals plaatwerk alsmede het verruimen van bestaande gaten in staal en RVS tot 2mm, non ferro tot 5mm.

Inhoud:

4-12mm (stappen van 1mm)

4-20mm (stappen van 2mm)

4-30mm (stappen van 2mm)



€ 84

734102

CONISCHE PLAATBOREN SET 3DLG

HSS, voor het boren van grotere gaten in dun materiaal zoals plaatwerk. Zelf centrerend
Inhoud; 3-14mm, 6-20mm, 16-30,5mm.



€ 71

TRAPPENBOREN

HSS, voor het boren van grotere gaten in dun materiaal zoals plaatwerk alsmede het verruimen van bestaande gaten in staal en RVS tot 2mm, non ferro tot 5mm.



734185 Trappenboor, 4-12mm (stappen van 1mm) € 28,00

734186 Trappenboor, 4-20mm (stappen van 2mm) € 36,00

734187 Trappenboor, 4-30mm (stappen van 2mm) € 52,00

734189 Trappenboor, 4-39mm (diverse stappen) € 85,00

CONISCHE PLAATBOREN

HSS, voor het boren van grotere gaten in dun materiaal zoals plaatwerk. Zelf centrerend.



734105 Conische plaatboor 3-14mm € 14,00

734106 Conische plaatboor 6-20mm € 20,00

734107 Conische plaatboor 16-30,5mm € 38,00



734115 Conische plaatboor met stop 2,5-7,8mm € 19,00

734002

VERZINKFREZENSET 6DLG

Voorzien van 3 snijvlakken, DIN335, TYPE C 90° HSS

Inhoud; 6,3/ 8,3/ 10,4/ 12,4/ 16,5/ 20,5mm.



€ 54

734950

GATENZAGEN SET 11DLG

Gatenzagen bimetaal, HSS-E (Co8), Cobalt, variabele vertanding voor snel en trillingvrij zagen, zaagdiepte 38mm. Voor gebruik in metaal.

Inhoud: 19, 22, 29, 35, 38, 44, 51, 57, 64mm en 2 zaaghouders



€ 139

VERZINKFREZEN

Voorzien van 3 snijvlakken, DIN335, TYPE C 90° HSS.



- 734005 Verzinkfrees 90° 6,3mm € 6,00
- 734006 Verzinkfrees 90° 8,3mm € 6,50
- 734007 Verzinkfrees 90° 10,4mm € 7,70
- 734008 Verzinkfrees 90° 12,4mm € 9,90
- 734009 Verzinkfrees 90° 16,5mm € 13,00
- 734010 Verzinkfrees 90° 20,5mm € 18,00

734951

GATENZAGEN SET 14DLG

Gatenzagen bimetaal, HSS-E (Co8), Cobalt, variabele vertanding voor snel en trillingvrij zagen, zaagdiepte 38mm. Voor gebruik in metaal.

Inhoud: 19, 22, 25, 29, 32, 35, 44, 51, 57, 64, 68, 76mm en 2 zaaghouders



€ 189

733902

DRAADSNIJSET 31DLG

Handtappen M3, M4, M5, M6, M8, M10 en M12 (per maat: voor-, midden-, en eindsnijder) DIN352, HSS-G, wringijzer DIN1814, snijplaten M3 t/m M12 (Ø25mm) DIN223B, snijplaat-houder (Ø25x9mm) DIN225, schroevendraaier.



€ 105

733904

DRAADSNIJSET 44DLG

Voorborensset: 2,5/ 3,3/ 4,2/ 5,0/ 6,8/ 8,5/ 10,2mm
Handtappen M3, M4, M5, M6, M8, M10 en M12 (per maat: voor-, midden-, en eindsnijder) DIN352, HSS-G, wringijzer DIN1814, snijplaten M3, M4, M5, M6 (Ø20mm), M8 (Ø25mm), M10 (Ø30mm), M12 (38mm), DIN223B, snijplaat-houders: Ø20x5, Ø20x7, Ø25x9, Ø30x11, Ø38x14mm, DIN225, schroevendraaier, draadmeter.



€ 145

HANDTAPPEN SETS

DIN352, HSS, TYPE M

3dlg, bestaande uit voor-/ midden-/ eindsnijder

- 733030 Handtappenset M3 € 9,00
- 733040 Handtappenset M4 € 9,00
- 733050 Handtappenset M5 € 9,90
- 733060 Handtappenset M6 € 9,90
- 733080 Handtappenset M8 € 11,50
- 733100 Handtappenset M10 € 14,00
- 733120 Handtappenset M12 € 18,50
- 733122 Handtappenset M14 € 24,50
- 733124 Handtappenset M16 € 29,50



734900

MACHINE TAPPENSET (KORT) 15DLG

DIN352 HSS-G, complete set om voor te boren en te tappen, incl verstelbaar wringijzer.

Boormaten: 2,5/ 3,3/ 4,2/ 5,0/ 6,8/ 8,5/ 10,2mm

Tapmaten: M3, M4, M5, M6, M8, M10, M12



€ 51

MACHINE TAPPEN (KORT)

DIN352 HSS-G

- 734903 Machine tap M3 € 5,00
- 734904 Machine tap M4 € 5,00
- 734905 Machine tap M5 € 5,00
- 734906 Machine tap M6 € 5,50
- 734908 Machine tap M8 € 5,80
- 734910 Machine tap M10 € 7,00
- 734912 Machine tap M12 € 9,00



METRISCHE SCHROEFDRAAD

Alle tappen zijn in normale draad, volgens DIN223B, 352, 225/ ISO 724. Gegevens Nominale Ø/ Spood:

M3 / 0.50	M6 / 1.00	M12 / 1.75
M4 / 0.70	M8 / 1.25	M14 / 2.00
M5 / 0.80	M10 / 1.50	M16 / 2.00

VERSTELBARE WRINGIJZERS



- 733601 M1-M10 € 6,00
- 733602 M1-M12 € 6,80
- 733603 M4-M12 € 10,00
- 733604 M5-M20 € 16,50

VERLENGSTUKKEN TBV HANDTAPPEN

- 733130 M3/ 80mm € 5,50
- 733131 M4/ 95mm € 5,80
- 733132 M5-M8/ 110mm € 7,50
- 733133 M9-M10/ 115mm € 8,50
- 733134 M12/ 125mm € 10,00
- 733135 M13-M16/ 135mm € 12,00



TAPKRUKRATELS



- 733610 Nr 1, tbv tappen M3- M10 € 9,80
- 733612 Nr 2, tbv tappen M5- M12 € 11,80

733700

SNIJPLATENSET 8DLG

DIN EN22568, HSS-G, M geslepen.

Inhoud; M3, M4, M5, M6, M8, M10, M12, incl snijplaathouder 25x9mm (Ø25mm).



€ 36,80

SNIJPLATEN DIN EN22568, HSS-G, M GESLEPEN

- 733703 Snijplaat M3 Ø20mm € 6,50
- 733704 Snijplaat M4 Ø20mm € 6,50
- 733705 Snijplaat M5 Ø20mm € 7,00
- 733706 Snijplaat M6 Ø20mm € 7,00
- 733708 Snijplaat M8 Ø25mm € 7,40
- 733720 Snijplaat M10 Ø25mm € 7,40
- 733710 Snijplaat M10 Ø30mm € 8,50
- 733712 Snijplaat M12 Ø38mm € 12,00



SNIJPLAATHOUDERS

- 733802 Snijplaathouder M3-M4 Ø20x5mm € 4,50
- 733804 Snijplaathouder M4-M5-M6 Ø20x7mm € 4,50
- 733806 Snijplaathouder M7-M9 Ø25x9mm € 5,00
- 733808 Snijplaathouder M10-M11 Ø30x11mm € 7,00
- 733810 Snijplaathouder M12-M14 Ø38x14mm € 10,50



734920

COMBI TAPPENSET 7DLG

Met één tap boren, draadsnijden en afbramen, HSS-G, M geslepen, 1/4" bitaansluiting, incl magneethouder.

Inhoud; M3, M4, M5, M6, M8, M10



€ 49,50

COMBITAPPEN

Met één tap boren, draadsnijden en afbramen, HSS-G, M geslepen, 1/4" bitaansluiting.

- 734923 Combitap M3 € 10,00
- 734924 Combitap M4 € 10,00
- 734925 Combitap M5 € 10,00
- 734926 Combitap M6 € 10,00
- 734928 Combitap M8 € 13,00
- 734930 Combitap M10 € 16,00



735501

SNELONTBRAMER MET VAST MES

Snelontbramer, geschikt voor metaal, aluminium, koper en kunststof



€ 7

735505

SNELONTBRAMER MET SNELWISSELHOUDER

Snelontbramer met verwisselbaar mes (735510), geschikt voor metaal, aluminium, koper en kunststof



735510 Set mesjes (10st) € 21

€ 11

735518

SCHRAPER 3-KANT

Schraper met verwisselbaar driehoek-mes (735519), geschikt voor metaal, aluminium, koper, messing, gietijzer, kunststof.



735519 Mes tbv schraper 3-kant € 18

€ 21

735600

BOUGIE SCHROEFDRAAD REPARATIESET 17DLG

Voor het herstellen van beschadigde schroefdraad; oude schroefdraad uitboren, nieuwe draad tappen en schroefdraadhuls inbrengen. Incl HSS STI tap MF14x1.25, montage-hulpstuk en 15 RVS schroefdraadhulzen in 3 verschillende lengten (alle componenten los leverbaar)



€ 69,50

SCHROEFDRAAD REPARATIESETS

Voor het herstellen van beschadigde schroefdraad; oude schroefdraad uitboren, nieuwe draad tappen en schroefdraadhuls inbrengen. Incl HSS boor, HSS STI tap, montage-hulpstuk, tap breker en RVS schroefdraadhulzen (alle componenten los leverbaar)



- 735534 M5x 0,80 /boor ø 5,2mm, 24dlg € 33,00
- 735535 M6x 1,00 /boor ø 6,3mm, 24dlg € 33,00
- 735536 M8x 1,25 /boor ø 8,3mm, 24dlg € 42,00
- 735537 M10x 1,50 /boor ø10,4mm, 19dlg € 45,00
- 735538 M12x 1,75 /boor ø12,4mm, 14dlg € 54,00

735508

SNELONTBRAMER MET COMFORT GRIP

Snelontbramer met verwisselbaar mes (735510) en comfort grip waarin tevens reservemesjes zijn op te bergen. Geschikt voor metaal, aluminium, koper en kunststof



735510 Set mesjes (10st) € 21

€ 19

735530

SCHROEFDRAAD REPARATIESET 130DLG

Voor het herstellen van beschadigde schroefdraad; oude schroefdraad uitboren, nieuwe draad tappen en schroefdraadhuls inbrengen. Incl HSS boren, HSS STI tappen, montagehulpstukken, tap brekers en RVS schroefdraadhulzen (alle componenten los leverbaar), M5x 0,80/boor \varnothing 5,2mm- M6x 1,00 /boor \varnothing 6,3mm- M8x 1,25 /boor \varnothing 8,3mm- M10x 1,50 /boor \varnothing 10,4mm- M12x 1,75 /boor \varnothing 12,4mm



€ 177

734192

TRAPPENBORENSSET COBALT, 3DLG

HSS-E (Co 5), Cobalt legering, voor het boren van grotere gaten en verruimen van bestaande gaten in (staal en) RVS

Inhoud:

4-12mm (stappen van 1mm)

4-20mm (stappen van 2mm)

4-30mm (stappen van 2mm)



€ 155

TRAPPENBOREN COBALT

HSS-E (Co 5), Cobalt legering, voor het boren van grotere gaten en verruimen van bestaande gaten in (staal en) RVS



734195 Trappenboor 4-12mm (stappen van 1mm) € 41,00

734196 Trappenboor 4-20mm (stappen van 2mm) € 56,00

734197 Trappenboor 4-30mm (stappen van 2mm) € 92,00

734198 Trappenboor 4-39mm (diverse stappen) € 134,00

734132

CONISCHE PLAATBORENSSET COBALT, 3DLG

HSS-E (Co 5), Cobalt legering, voor het boren van grotere gaten en verruimen van bestaande gaten in (staal en) RVS. Zelf centreren.

Inhoud; 3-14mm, 8-20mm, 16-30,5mm.



€ 106

734022

VERZINKFREZEN SET COBALT, 6DLG

Voorzien van 3 snijvlakken, DIN335C, TYPE C 90° HSS-E, Cobalt legering, voor RVS gebruik.

Inhoud; 6,3/ 8,3/ 10,4/ 12,4/ 16,5/ 20,5mm.



€ 79

CONISCHE PLAATBOREN COBALT

HSS-E (Co 5), Cobalt legering, voor het boren van grotere en van bestaande gaten in (staal en) RVS.



734135 Conische plaatboor, cobalt 3-14mm € 20,00

734136 Conische plaatboor, cobalt 6-20mm € 28,00

734137 Conische plaatboor, cobalt 16-30,5mm € 46,00

VERZINKFREZEN COBALT

Voorzien van 3 snijvlakken, DIN335C, TYPE C 90° HSS-E, Cobalt legering, voor RVS gebruik.



734025 Verzinkfrees 90°, cobalt 6,3mm € 8,00

734026 Verzinkfrees 90°, cobalt 8,3mm € 9,50

734027 Verzinkfrees 90°, cobalt 10,4mm € 11,00

734028 Verzinkfrees 90°, cobalt 12,4mm € 12,50

734029 Verzinkfrees 90°, cobalt 16,5mm € 16,00

734030 Verzinkfrees 90°, cobalt 20,5mm € 21,00

Y420250

GARAGEKRIK 2 TON/ LAAG

Garage krik met ultra lage bouwhoogte en 2 ton hefvermogen. Voorzien van een hydraulische unit met snellift systeem dat ervoor zorgt dat de krik even snel onbelast als met lading heft. Min/ max hefhoogte: 75/510(!) mm. De poly-urethaan wielen zijn geluid reducerend en voorkomen beschadigingen aan garagevloeren, onmisbaar indien deze voorzien zijn van een oliedichte coating. De schotel wordt bedekt door een rubber bescherm pad, deze voorkomt schade aan de onderzijde van het chassis. Cardan overbrenging, zeer soepel manoeuvreerbaar.



€ 149

Y420330

GARAGEKRIK 3 TON

Allround krik met 3 ton hefvermogen. Voorzien van een hydraulische unit met snellift systeem dat ervoor zorgt dat de krik even snel onbelast als met lading heft. Min/ max hefhoogte: 120/450mm. De poly-urethaan wielen zijn geluid reducerend en voorkomen beschadigingen aan garagevloeren, onmisbaar indien deze voorzien zijn van een oliedichte coating. De schotel wordt bedekt door een rubber bescherm pad, deze voorkomt schade aan de onderzijde van het chassis. Cardan overbrenging.



€ 179

Y420333

GARAGEKRIK 3 TON/ LAAG, VOETPEDAAL

PU wielen, laag profiel, voetpedaal, Turbo Lift, ACD/automatische remfunctie tijdens zakken, min/max hoogte: 76/503mm.



€ 269

POTKRIKS

Heavy Duty potkriks, worden gebruikt voor meerdere toepassingen: heffen, buigen, persen of rechten. Het volledige gamma komt met een gietijzeren voet, gepolijste en verchroomde plunjers. Kunnen in zowel horizontale als verticale posities worden gebruikt.



Y410200	2 ton	H-min/ max: 158/308mm	€ 24,00
Y410400	4 ton	H-min/ max: 180/350mm	€ 31,00
Y410600	6 ton	H-min/ max: 197/382mm	€ 38,00
Y411200	12 ton	H-min/ max: 214/399mm	€ 66,00
Y412000	20 ton	H-min/ max: 244/449mm	€ 95,00
Y412001	20 ton	H-min/ max: 190/340mm	€ 85,00
Y413000	30 ton	H-min/ max: 285/465mm	€ 129,00

YM411355

GARAGEKRIK ALUMINIUM 1,5T

Lage aluminium garage krik, compact design en ultra licht in gewicht; slechts 14,2kg! Voorzien van een hydraulische unit met snellift systeem en 2 zaksnelheden. Hefvermogen 1,5 ton. Min/ max hefhoogte: 90/360mm. Rubber bescherm pad, handig en snel uitneembare hendel, afm.: lxb 481x 213/247mm



€ 159

Y411350

GARAGEKRIK ALUMINIUM 1,35 TON

Aluminium garage krik, ultra licht in gewicht; slechts 10kg! Hefvermogen 1,35 ton. Min/ max hefhoogte: 80/375mm. Gewicht besparende Heavy Duty nylon wielen, de schotel wordt bedekt door een rubber bescherm pad, deze voorkomt schade aan de onderzijde van het chassis. Cardan overbrenging.



€ 219

ASSTEUNEN/ 2 STUKS (RATEL TYPE)

Gelaste assteunset (2 stuks), voorzien van handig verstel-systeem voor makkelijk en veilig verstellen van de steunhoogte.



Y450301 Set, 3 ton (min/max hoogte 292/432mm) € 48,00

Y451600 Set, 6 ton (min/max hoogte 390/618mm) € 99,00

Y451205

ASSTEUNSET 2 STUKS 12T / MET WIELEN

Hoogteverstelling met gat-pin principe, voorzien van handige transportwielen. Set, 12 ton (min/max hoogte 302/450mm)



€ 209

ASSTEUNSET/ 2 STUKS (PIN TYPE)

Hoogteverstelling met gat-pin principe, PU bescherming op de carrossieresteun



Y452300 Set, 3 ton (min/max hoogte 322/465) € 68,00

Y452600 Set, 6 ton (min/max hoogte 404/604) € 135,00

WERKHANDSCHOENEN

Uitstekende pasvorm, bescherming op de rug, knokkels en vingers. De rugkant is gemaakt van stretch-nylon, handpalm uit synthetisch leder met antislip voor optimale grip. Badstof duim om zweet weg te vegen, elastische sluiting met klittenband. Voldoet aan EN420/EN388 norm, wasbaar (max. 30°).



Y491110L Maat L

Y491110XL Maat XL

€ 24

Y440300

MOTORMONTAGESTEUN 300KG

Voorzien van instelbare steunen met bescherming voor de carrosserie, instelbare spindel met ketting. Breedte instelbaar; min 106cm /max 156cm.



€ 95

Y471123

SMART DISC/ WIELENTPORTER (MAX 160KG/ Ø68CM)

De nieuwe Smart Disc garandeert meer mobiliteit en flexibiliteit in de bandenshop. Wielen- en bandensets tot 160kg kunnen moeiteloos bij en rond het voertuig geplaatst worden. Ook ideaal om winter/zomer sets te presenteren in de showroom. Tevens is de Smart Disc te combineren met de wieltransporter (Y471147).



€ 75

Y471105

WHEEL DOLLY

Met deze wielheffer is het heel eenvoudig zware wielen/ banden van vrachtauto's en bussen te monteren en demonteren. Voorkomt beschadigingen aan wielnaaf en de velg. Rollers van zware lagers voorzien en afhankelijk van de wielgrootte instelbaar in 3 posities. Onmisbaar voor elke service truck. Geschikt voor wielen met velgmaat 6.5" – 24.5".



€ 165

Y451550

TRANSMISSIEKRIK, 550KG, PU WIELEN

De brede basis biedt optimale stabiliteit en het efficiënte pompsysteem zorgt voor een snel en precies bereik tot de last. 550kg, omkeerbare kroon met zadel. H-min/max: 1205/2015mm.



Y451550ADAP

Transmissiekrik adaptor
Traploos in alle hoeken verstelbaar,
lxb= 30x30cm, gewicht 13kg € 95,00

€ 399

Y450101

MOTORSTANDAARD

Motorstandaard 400kg, 360° draaibaar.
Inclusief montagehulpstukken



€ 115

Y471106

WHEELDOLLY, HYDRAULISCH

Zware heavy duty wheeldolly, geschikt voor de meest zware omstandigheden en onmisbaar voor hulpacties op een smalle vluchtstrook. Ivm compacte bouw en inklapbaar frame makkelijk mee te nemen in een servicewagen. Handmatig tillen en manoeuvreren van zware wielen is niet meer aan de orde.

Handig onder het wiel te positioneren en omhoog te krikken tot de gewenste hoogte. Geschikt voor wielen met velgmaat 6.5" – 24.5".



€ 359

Y471147

WIELTRANSPORTER

De perfecte oplossing voor het transporteren van zware wielensets op de meest ergonomisch verantwoorde wijze. Voorzien van een gepatenteerd lift-systeem waarmee het kantelen van de transporter weinig moeite kost. De armen openen en sluiten automatisch om het onderste wiel heen, zo is het heel eenvoudig een stapel wielen vanaf de vloer op te tillen en te transporteren. Perfect te combineren met de Wheelassist! Geschikt voor velgmaten tot 20", capaciteit tot 200kg! Massieve rubber wielen.



€ 279

YZ4711SPP

UITBREIDINGSET TBV WIELTRANSPORTER

De SPP kit brengt voordeel wanneer er naast wielen sets ook regelmatig met grotere hoeveelheden banden wordt gereden. Door aan de hendel te trekken wordt de bandenkar als het ware van de bandenstapel weggedrukt (handig als het om een gecoate, gladde vloer gaat!) Het verlengstuk maakt het mogelijk tot op grote hoogte te stapelen.



€ 83

LUCHTHYDRAULISCHE GARAGEKRIJKS

Voor zware inzet, pneumatisch aangestuurd via de controller in de handle, voorzien van dodemansknop voor het gegarandeerd veilig laten zakken van de zwaarste trucks. In 2 varianten leverbaar;

Y432024

Cap 24ton. Min/max hoogte 215/356mm (441mm incl uitstelschroef), lxb = 525x 265mm, stanglengte 1240mm. Met 3 verlengstukken: 20, 50, 100mm.

Y432032

Cap 32/16ton (telescopisch; 2e trap 16ton). Min hoogte slechts 150mm! Max hoogte 1e/2e trap: 223/289mm, lxb = 480x 290mm, stanglengte 1300mm. Met 2 verlengstukken: 45, 100mm (op elkaar te gebruiken).



€ 725



€ 1095

Y440102

WERKPLAATSKRAAN 1000KG

Zeer praktische opvouwbare werkplaatskraan, voorzien van draaibare cilinder zodat onder elke hoek de hefboom omhoog gepompt kan worden. Uitgerust met snellift principe, eindeloos pompen behoort daarmee tot het verleden, het bereiken van de gewenste hoogte gaat 2x sneller dan traditionele modellen. Nylon wielen zorgen voor makkelijke en geruisloze verplaatsing. Hold to run bediening voor maximale veiligheid.

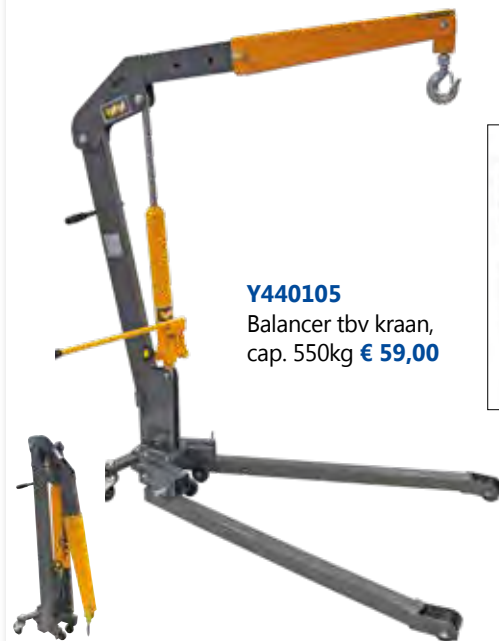

Y440105

Balancer tbv kraan, cap. 550kg € 59,00

€ 499

CTB8805
TOPKOFFER

COMPACT
SIZE

LxBxH: 620x 335x 430mm
5x Lade 540x300x50mm
Gewicht: 24,5kg



€ 349

CTB8807
TOPKOFFER

KING SIZE

LxBxH: 805x350x495mm
3x Lade 220x300x50mm
4x Lade 725x300x50mm
Gewicht: 33,6kg



€ 359

CTB8905
TOPKOFFER

KING SIZE
DE LUXE

LxBxH: 805x350x495mm
5x Lade 725x440x70mm
Gewicht: 52,4kg



€ 679

CTB9906
GEREEDSCHAPSWAGEN

COMPACT
SIZE

LxBxH: 650x 510x 940mm, laden volledig
uitschuifbaar, gewicht: 66,7kg



€ 549

CTB9907
GEREEDSCHAPSWAGEN

KING SIZE

LxBxH: 840x 510x 940mm, laden volledig
uitschuifbaar, gewicht: 76kg



€ 699

CTB9908
GEREEDSCHAPSWAGEN

KING SIZE
DE LUXE

LxBxH: 930x 510x 940mm, laden volledig
uitschuifbaar, gewicht: 82kg



€ 899

COMPACT
SIZE



KING SIZE



KING SIZE
DE LUXE



COMPACT SIZE

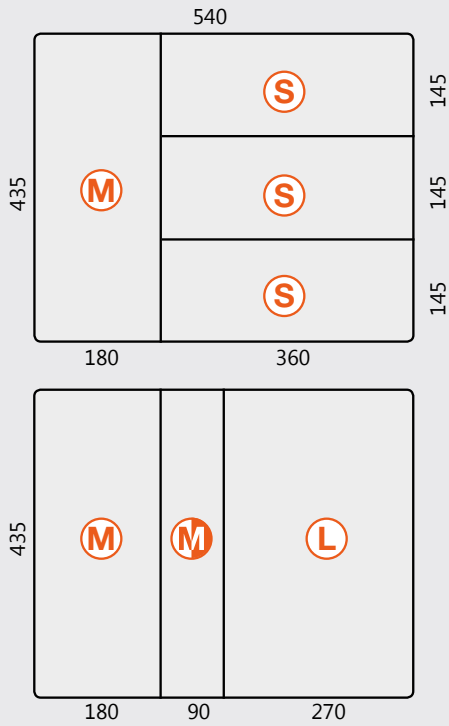

KING SIZE / KING SIZE DE LUXE

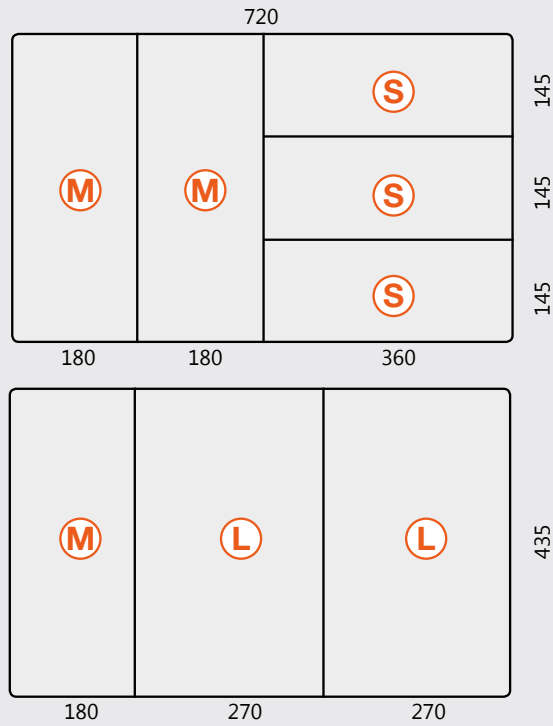

- S** module: 360 x 145mm
- M** module: 435 x 90mm
- M** module: 435 x 180mm
- L** module: 435 x 270mm

CTB99063

GEREEDSCHAPSWAGEN COMPACT SIZE, 3 LADEN GEVULD

COMPACT
SIZE



- CTK02017S** 1/4" Doppenset, 17pcs
- CSB02028S** 1/4" Doppenset, 28pcs
- CSS02611S** 1/4" Doppenset lang 6-kant, 11pcs
- CTK04022S** 1/2" Doppenset, 22pcs
- CSS04613S** 1/2" Doppenset lang 6-kant, 13pcs

- CSD81214S** Schroevendraaierset, 14pcs
- 900902** Accessoire module
- CWS32418S** Steekringsleutelset, 18pcs



- CHP12008S** Hamer en pendrijverset, 8pcs
- CCP10002S** Tangenset, 2pcs
- CCP06004S** Borgringtangenset, 4pcs
- CCP08004S** Tangenset, 4pcs



INCL. 11
MODULES



€ 959

CTB99065

GEREEDSCHAPSWAGEN COMPACT SIZE, 5 LADEN GEVULD

COMPACT
SIZE



- CTK02017S** 1/4" Doppenset, 17pcs
- CSB02028S** 1/4" Doppenset, 28pcs
- CSS02611S** 1/4" Doppenset lang 6-kant, 11pcs
- CTK04022S** 1/2" Doppenset, 22pcs
- CSS04613S** 1/2" Doppenset lang 6-kant, 13pcs

- CSD81214S** Schroevendraaierset, 14pcs
- 900902** Accessoire module
- CWS32418S** Steekringsleutelset, 18pcs

- CHP12008S** Hamer en pendrijverset, 8pcs
- CCP10002S** Tangenset, 2pcs
- CCP06004S** Borgringtangenset, 4pcs
- CCP08004S** Tangenset, 4pcs



- CSD82008S** Torx schroevendraaierset, 8pcs
- CKW15008S** Inbus T-Sleutelset, 8pcs
- CKW16008S** Torx T-Sleutelset, 8pcs

- CWS41912S** Steekring-ratelsleutelset L-R, 12pcs
- CSB17018S** 1/2" Doppenset inbus, 18pcs
- CSB18018S** 1/2" Doppenset, 18pcs



INCL. 17
MODULES



€ 1195

CTB99068

GEREDSCHAPSWAGEN COMPACT SIZE, 3 LADEN GEVULD IN FOAM

COMPACT
SIZE

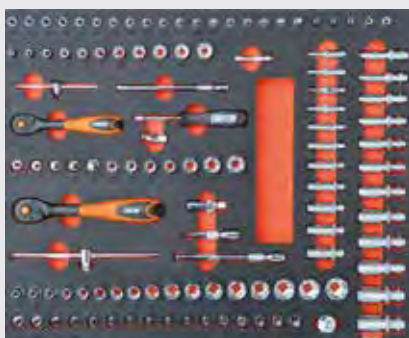

- CTK02017S** 1/4" Doppenset, 17pcs
- CSB02028S** 1/4" Doppenset, 28pcs
- CSS02611S** 1/4" Doppenset lang 6-kant, 11pcs
- CTK03022S** 3/8" Doppenset, 22pcs
- CSB03032S** 3/8" Doppenset, 32pcs
- CSS03612S** 3/8" Doppenset lang 6-kant, 12pcs

- CHP12008S** Hamer en pendrijverset, 8pcs
- CWS32418S** Steekringsleutelset, 18pcs
- CSD81214S** Schroevendraaierset, 14pcs

- CCP10002S** Tangenset, 2pcs
- CSD82008S** Torx schroevendraaierset, 8pcs
- CCP08004S** Tangenset, 4pcs
- CCP06004S** Borgringtangenset, 4pcs



FOAM
MODULES

INCL. 13
MODULES

3



€1075

CTB99069

GEREEDSCHAPSWAGEN COMPACT SIZE, 5 LADEN GEVULD IN FOAM

COMPACT
SIZE

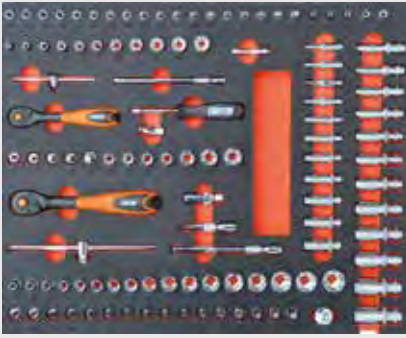

- CTK02017S** 1/4" Doppenset , 17pcs
- CSB02028S** 1/4" Doppenset, 28pcs
- CSS02611S** 1/4" Doppenset lang 6-kant, 11pcs
- CTK03022S** 3/8" Doppenset, 22pcs
- CSB03032S** 3/8" Doppenset, 32pcs
- CSS03612S** 3/8" Doppenset lang 6-kant, 12pcs

- CTK04022S** 1/2" Doppenset, 22pcs
- CSS04613S** 1/2" Doppenset lang 6-kant, 13pcs
- CSB17018S** 1/2" Doppenset inbus, 18pcs
- CSB18018S** 1/2" Doppenset Torx, 18pcs

- CHP12008S** Hamer en pendrijverset, 8pcs
- CWS32418S** Steekringsleutelset, 18pcs
- CSD81214S** Schroevendraaierset, 14pcs

- CCP10002S** Tangenset, 2pcs
- CSD82008S** Torx schroevendraaierset, 8pcs
- CCP08004S** Tangenset, 4pcs
- CCP06004S** Borgringtangenset, 4pcs

- CKW15008S** Inbus T-Sleutelset, 8pcs
- CKW16008S** Torx T-Sleutelset, 8pcs
- CWS41912S** Steekring-ratelsleutelset L-R, 12pcs

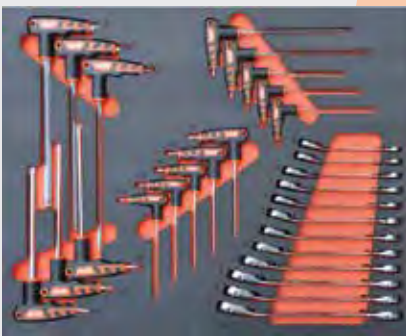

FOAM
MODULES

INCL. 20
MODULES



€ 1525

CTB99071

GEREEDSCHAPSWAGEN KING SIZE, 3 LADEN GEVULD

KING SIZE



- CCP08004S** Tangenset, 4pcs
- CTK02017S** 1/4" Doppenset, 17pcs
- CSB02028S** 1/4" Doppenset, 28pcs
- CTK03022S** 3/8" Doppenset, 22pcs
- CSB03032S** 3/8" Doppenset, 32pcs
- CTK04022S** 1/2" Doppenset, 22pcs

- CHP12008S** Hamer en pendrijverset, 8pcs
- CSB17018S** 1/2" Doppenset inbus, 18pcs
- CSB18018S** 1/2" Doppenset Torx, 18pcs
- CSD81214S** Schroevendraaierset, 14pcs

- CND51309S** T-Dopsleutelset, 9pcs
- CSD82008S** Torx schroevendraaierset, 8pcs
- CWS32418S** Steekringsleutelset, 18pcs



INCL. **13**
MODULES



€1175

CTB99074

GEREEDSCHAPSWAGEN KING SIZE, 4 LADEN GEVULD

KING SIZE



- CCP08004S** Tangenset, 4pcs
- CTK02017S** 1/4" Doppenset, 17pcs
- CSB02028S** 1/4" Doppenset, 28pcs
- CTK03022S** 3/8" Doppenset, 22pcs
- CSB03032S** 3/8" Doppenset, 32pcs
- CTK04022S** 1/2" Doppenset, 22pcs

- CHP12008S** Hamer en pendrijverset, 8pcs
- CSB17018S** 1/2" Doppenset inbus, 18pcs
- CSB18018S** 1/2" Doppenset Torx, 18pcs
- CSD81214S** Schroevendraaierset, 14pcs



- CND51309S** T-Dopsleutelset, 9pcs
- CSD82008S** Torx schroevendraaierset, 8pcs
- CWS32418S** Steekringsleutelset, 18pcs

- CWS53210S** Ringsleutelset gebogen, 10pcs
- CKW15008S** Inbus T-Sleutelset, 8pcs
- CKW16008S** Torx T-Sleutelset, 8pcs
- CWS41912S** Steekring-ratelsleutelset L-R, 12pcs



INCL. 17
MODULES



€1450

CTB99072**GEREEDSCHAPSWAGEN KING SIZE, 5 LADEN GEVULD****KING SIZE**

CCP08004S Tangenset, 4pcs
CTK02017S 1/4" Doppenset, 17pcs
CSB02028S 1/4" Doppenset, 28pcs
CTK03022S 3/8" Doppenset, 22pcs
CSB03032S 3/8" Doppenset, 32pcs
CTK04022S 1/2" Doppenset, 22pcs

CHP12008S Hamer en pendrijverset, 8pcs
CSB17018S 1/2" Doppenset inbus, 18pcs
CSB18018S 1/2" Doppenset Torx, 18pcs
CSD81214S Schroevendraaierset, 14pcs

CND51309S T-Dopsleutelset, 9pcs
CSD82008S Torx schroevendraaierset, 8pcs
CWS32418S Steekringsleutelset, 18pcs

CWS53210S Ringsleutelset gebogen, 10pcs
CKW15008S Inbus T-Sleutelset, 8pcs
CKW16008S Torx T-Sleutelset, 8pcs
CWS41912S Steekring-ratelsleutelset L-R, 12pcs

CCT14003S Set mes, schaar, zaag, 3pcs
CCP10002S Tangenset, 2pcs
CWS62208S Kniesleutelset, 8pcs
CHR67004S Blindklinknageltang
CFS81005S Vijlenset, 5pcs

**INCL. 22
MODULES****€ 1650**

CTB99078

GEREDSCHAPSWAGEN KING SIZE, 4 LADEN GEVULD IN FOAM

KING SIZE

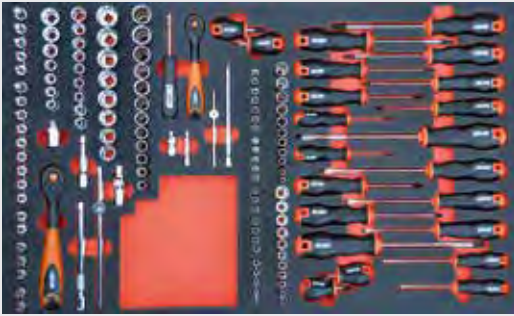

- CTK02017S** 1/4" Doppenset, 17pcs
- CSB02028S** 1/4" Doppenset, 28pcs
- CSS02611S** 1/4" Doppenset lang 6-kant, 11pcs
- CTK03022S** 3/8" Doppenset, 22pcs
- CSS03612S** 3/8" Doppenset lang 6-kant, 12pcs
- CSB03032S** 3/8" Doppenset, 32pcs
- CSD81214S** Schroevendraaierset, 14pcs
- CSD82008S** Torx schroevendraaierset, 8pcs

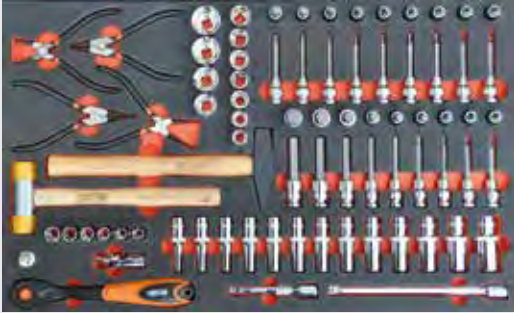

- CCP06004S** Borgringtangenset, 4pcs
- CHP1200801** Hamer 500gr
- CHP1200802** Hamer kunststof kop
- CTK04022S** 1/2" Doppenset, 22pcs
- CSS04613S** 1/2" Doppenset lang 6-kant, 13pcs
- CSB17018S** 1/2" Doppenset inbus, 18pcs
- CSB18018S** 1/2" Doppenset Torx, 18pcs

- CKW15008S** Inbus T-Sleutelset, 8pcs
- CKW16008S** Torx T-Sleutelset, 8pcs
- CND51309S** T-Dopsleutelset, 9pcs

- CWS41912S** Steekring-ratelsleutelset L-R, 12pcs
- CWS53210S** Ringsleutelset gebogen, 10pcs
- CWS32418S** Steekringsleutelset, 18pcs
- CCP08004S** Tangenset, 4pcs

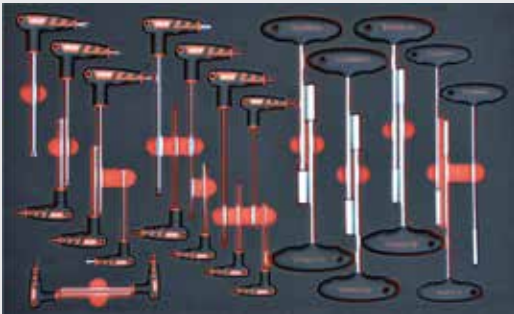

FOAM
MODULES

INCL. 20
MODULES



€ 1750

CTB99079**GEREEDSCHAPSWAGEN KING SIZE, 5 LADEN GEVULD IN FOAM****KING SIZE**

- CTK02017S** 1/4" Doppenset/ Jeu de douilles, 17pcs
- CSB02028S** 1/4" Doppenset/ Jeu de douilles, 28pcs
- CSS02611S** 1/4" Doppenset lang 6-kant, 11pcs
- CTK03022S** 3/8" Doppenset, 22pcs
- CSS03612S** 3/8" Doppenset lang 6-kant, 12pcs
- CSB03032S** 3/8" Doppenset, 32pcs
- CSD81214S** Schroevendraaierset, 14pcs
- CSD82008S** Torx schroevendraaierset, 8pcs



- CCP06004S** Borgringtangenset, 4pcs
- CHP12008S** Hamer en pendrijverset, 8pcs
- CTK04022S** 1/2" Doppenset, 22pcs
- CSS04613S** 1/2" Doppenset lang 6-kant, 13pcs
- CSB17018S** 1/2" Doppenset inbus, 18pcs
- CSB18018S** 1/2" Doppenset Torx, 18pcs

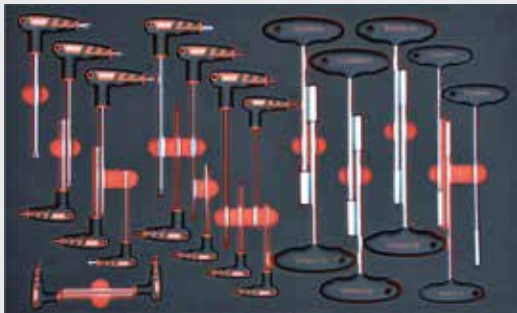

- CKW15008S** Inbus T-Sleutelset, 8pcs
- CKW16008S** Torx T-Sleutelset, 8pcs
- CND51309S** T-Dopsleutelset, 9pcs

- CWS41912S** Steekring-ratelsleutelset L-R, 12pcs
- CWS53210S** Ringsleutelset gebogen, 10pcs
- CWS32418S** Steekringsleutelset, 18pcs
- CCP08004S** Tangenset, 4pcs



- CCT14003S** Set mes, schaar, zaag, 3pcs
- CFS81005S** Vijlenset, 5pcs
- CWS62208S** Kniesleutelset, 8pcs
- CKW65209S** Inbussleutelset extra lang, 9pcs
- CKW65309S** Torxsleutelset extra lang, 9pcs
- CCP10002S** Tangenset, 2pcs
- CTK0248301** Rolmaat 5mtr

**FOAM
MODULES****INCL. 27
MODULES****€1980**

CTB99082**GEREEDSCHAPSWAGEN KING SIZE DE LUXE, 5 LADEN GEVULD****KING SIZE
DE LUXE**

- CCP08004S** Tangenset, 4pcs
- CTK02017S** 1/4" Doppenset, 17pcs
- CSB02028S** 1/4" Doppenset, 28pcs
- CTK03022S** 3/8" Doppenset, 22pcs
- CSB03032S** 3/8" Doppenset, 32pcs
- CTK04022S** 1/2" Doppenset, 22pcs

- CHP12008S** Hamer en pendrijverset, 8pcs
- CSB17018S** 1/2" Doppenset inbus, 18pcs
- CSB18018S** 1/2" Doppenset Torx, 18pcs
- CSD81214S** Schroevendraaierset, 14pcs

- CND51309S** T-Dopsleutelset, 9pcs
- CSD82008S** Torx schroevendraaierset, 8pcs
- CWS32418S** Steekringsleutelset, 18pcs

- CWS53210S** Ringsleutelset gebogen, 10pcs
- CKW15008S** Inbus T-Sleutelset, 8pcs
- CKW16008S** Torx T-Sleutelset, 8pcs
- CWS41912S** Steekring-ratelsleutelset L-R, 12pcs

- CCT14003S** Set mes, schaar, zaag, 3pcs
- CCP10002S** Tangenset, 2pcs
- CWS62208S** Kniesleutelset, 8pcs
- CHR67004S** Blindklinknageltang
- CFS81005S** Vijlenset, 5pcs

**INCL. 22
MODULES****€ 1899**

CTB99089**GEREEDSCHAPSWAGEN KING SIZE DE LUXE, 5 LADEN GEVULD IN FOAM****KING SIZE
DE LUXE**

- CTK02017S** 1/4" Doppenset, 17pcs
- CSB02028S** 1/4" Doppenset, 28pcs
- CSS02611S** 1/4" Doppenset lang 6-kant, 11pcs
- CTK03022S** 3/8" Doppenset, 22pcs
- CSS03612S** 3/8" Doppenset lang 6-kant, 12pcs
- CSB03032S** 3/8" Doppenset, 32pcs
- CSD81214S** Schroevendraaierset, 14pcs
- CSD82008S** Torx schroevendraaierset, 8pcs



- CCP06004S** Borgringtangenset, 4pcs
- CHP12008S** Hamer en pendrijverset, 8pcs
- CTK04022S** 1/2" Doppenset, 22pcs
- CSS04613S** 1/2" Doppenset lang 6-kant, 13pcs
- CSB17018S** 1/2" Doppenset inbus, 18pcs
- CSB18018S** 1/2" Doppenset Torx, 18pcs

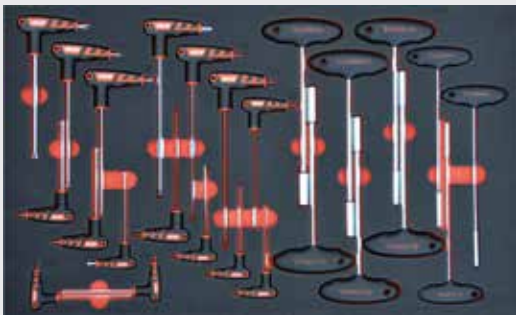

- CKW15008S** Inbus T-Sleutelset, 8pcs
- CKW16008S** Torx T-Sleutelset, 8pcs
- CND51309S** T-Dopsleutelset, 9pcs



- CWS41912S** Steekring-ratelsleutelset L-R, 12pcs
- CWS53210S** Ringsleutelset gebogen, 10 pcs
- CWS32418S** Steekringsleutelset, 18pcs
- CCP08004S** Tangenset, 4pcs



- CCT14003S** Set mes, schaar, zaag, 3pcs
- CFS81005S** Vijlenset, 5pcs
- CWS62208S** Kniesleutelset, 8pcs
- CKW65209S** Inbus sleutelset extra lang, 9pcs
- CKW65309S** Torx sleutelset extra lang, 9pcs
- CCP10002S** Tangenset, 2pcs
- CTK0248301** Rolmaat 5mtr

**FOAM
MODULES****INCL. 27
MODULES****€ 2295**

CTB950

FOAM INLAY MET PERSLUCHTGEREEDSCHAP

KING SIZE

KING SIZE
DE LUXE

Inhoud:

- SR5290N** 1/2" Slagmoersleutel
- SK6926CM** 1/2" Krachtdoppenset, 10 t/m 17-19-21-22-24 mm, lang, 12pcs
- SK12L18** 1/2" Krachtdop, 18mm lang
- SK12E125** 1/2" Verlengstuk 125mm
- CTW04332A** 1/2" Momentsleutel 17-332Nm
- SR5266** 1/2" Ratel
- SR5251** 3/8" Ratel
- SR1012RSS** 10mm Boormachine
- 730002** Boorcassette, 1-10mm, HSS

Afm.: 720x435mm



540200

FOAM INLAY MET 1/2" KRACHTDOPPEN/

KING SIZE

KING SIZE
DE LUXE

Inhoud:

- 6-kant:** 10-11-12-13-14-15-16-17-18-19-20-21-22-24-25-26-27-30-32-36mm.
- 6-kant lang:** 10-11-12-13-14-15-16-17-18-19-20-21-22-24-25- 26-27-30-32-36mm.
- 6-kant lang dunwandig:** 15-17-19-21-22mm
- 12-Kant lang:** 10-11-12-13-14-15-16-17-19-21-22-24-27-30-32-36mm.
- Inbus:** H6, H7, H8, H10, H12, H14, H17, H19. Torx: T25, T27, T30, T40, T45, T50, T55, T60.
- Spiraaldoppen inwendig:** 17-19-21-22mm
- Adaptors:** 3/8"-1/2", 1/2"-3/4", 1/2"-3/8", 3/4"-1/2"
- Kniestuk:** 1/2"
- Verlengstukken:** 1/2"- 75mm, 125mm, 250mm.

Afm.: 720x435mm



ACCESSOIRES

COMPACT
SIZE

KING SIZE

CST98
PAPIERROLHOUDER



€ 22,50

900510
AFVALBAK



€ 49

CST99
SPUITBUSHOUDER



€ 28

900520
RUBBER WERKMAT
(Afm 820x495x16mm)
Oliebestendig



€ 25



ACCESSOIRES

KING SIZE
DE LUXE

CST90C
PAPIERROLHOUDER
(26 cm)

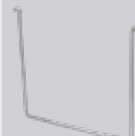

€ 6

CST90B
AFVALBAK



€ 36

CST90A
SPUITBUSHOUDER



€ 22

529807
OPHANGBEUGEL

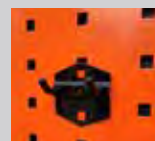

€ 3,50



CTB88073

TOPKOFFER INCL. GEREEDSCHAP IN FOAM

Inhoud

- CWS32418S** Steekringsleutelset, 18pcs
- CTK02017S** 1/4" Doppenset 1/4", 17pcs
- CSB02028S** 1/4" Doppenset 1/4", 28pcs
- CTK04022S** 1/2" Doppenset 1/2", 22pcs
- CCP08004S** Tangenset, 4pcs
- CHP1200801** Hamer 500gr
- CKW65209S** Inbussleutelset, extra lang, 9pcs
- CKW65309S** Torxsleutelset, extra lang, 9pcs

EXTRA

1 beitel, 2 doorslagen, led zaklamp (niet afgebeeld), waterpomptang, rolmaat, 110/250V spanningzoeker, schaar, zaag, schroevendraaiers.



FOAM
MODULES



Lxbxh: 805x350x495mm

€ 849



RATEL KUNSTSTOF, 72 T



- CRHC84272** 1/4", l=150mm € 18,00
CRHC84372 3/8", l=198mm € 19,50
CRHC84472 1/2", l=255mm € 27,00

MOMENTSLEUTELS









- CTW02024C** 1/4", 2-24Nm, l=250mm € 69,00
CTW02022A 1/4", 4-22Nm, l=325mm € 99,00
CTW03105A 3/8", 17-105Nm, l=435mm € 115,00
CTW04332A 1/2", 47-332Nm, l=615mm € 118,00
CTW06420C 3/4", 70-420Nm, l=670mm € 149,00

CTK02017S

1/4" DOPPENSET, 17PCS



- | | | |
|---|-----------------------|---|
|  | CX14K04 4mm | CX14K10 10mm |
| | CX14K05 5mm | CX14K11 11mm |
| | CX14K06 6mm | CX14K12 12mm |
| | CX14K07 7mm | CX14K13 13mm |
| | CX14K08 8mm | CX14K14 14mm |
| | CX14K09 9mm | |
|  | CX14W |  CX14SP 1/4" |
|  | CX14E050 50mm |  CX14U14 1/4" |
|  | CX14E150 150mm | |
|  | CRHC84272 1/4" | |











€ 42,50

CSB02028S

1/4" DOPPENSET, 28PCS



- | | | | |
|---|-----------------------|---|-----------------------|
|  | CX14P04 4,0mm |  | CX14T10 T10 |
| | CX14P055 5,5mm | | CX14T15 T15 |
| | CX14P065 6,5mm | | CX14T20 T20 |
|  | CX14PH1 PH1 | | CX14T25 T25 |
| | CX14PH2 PH2 | | CX14T27 T27 |
|  | CX14PZ1 PZ1 | | CX14T30 T30 |
| | CX14PZ2 PZ2 | | CX14T40 T40 |
|  | CX14H3 3mm |  | CX14ET04 E4 |
| | CX14H4 4mm | | CX14ET05 E5 |
| | CX14H5 5mm | | CX14ET06 E6 |
| | CX14H6 6mm | | CX14ET07 E7 |
| | CX14H8 8mm | | CX14ET08 E8 |
|  | CX14W |  | CX14E050 50mm |
| | | | CX14E150 150mm |
| | |  | CX14U14 1/4" |



€ 35

CSS02611S

1/4" DOPPENSET LANG 6PT, 11PCS



- | | | |
|--|--------------------|---------------------|
|  | CX14L04 4mm | CX14L10 10mm |
| | CX14L05 5mm | CX14L11 11mm |
| | CX14L06 6mm | CX14L12 12mm |
| | CX14L07 7mm | CX14L13 13mm |
| | CX14L08 8mm | CX14L14 14mm |
| | CX14L09 9mm | |



€ 24

CSS02011S

1/4" DOPPENSET LANG 12PT, 11PCS



- | | | |
|---|-------------------------|--------------------------|
|  | CX14L04 12PT 4mm | CX14L10 12PT 10mm |
| | CX14L05 12PT 5mm | CX14L11 12PT 11mm |
| | CX14L06 12PT 6mm | CX14L12 12PT 12mm |
| | CX14L07 12PT 7mm | CX14L13 12PT 13mm |
| | CX14L08 12PT 8mm | CX14L14 12PT 14mm |
| | CX14L09 12PT 9mm | |





€ 27

CTK03022S

3/8" DOPPENSET, 22PCS

(S)

	CX38K06	6mm
	CX38K07	7mm
	CX38K08	8mm
	CX38K09	9mm
	CX38K10	10mm
	CX38K11	11mm
	CX38K12	12mm
	CX38K13	13mm
	CX38K14	14mm
	CX38K15	15mm
	CX38K16	16mm
	CX38K17	17mm
	CX38K18	18mm
	CX38K19	19mm
	CX38K20	20mm
	CX38K21	21mm
	CX38K22	22mm

	CRHC84372	3/8"
	CX38U38	3/8"

	CX12A38	1/2" female x 3/8" male
--	----------------	-------------------------

	CX38E075	75mm
	CX38E150	150mm











€ 49,50

CSB03032S

3/8" DOPPENSET, 32PCS

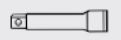
(S)

	CX38P055	5,5mm
	CX38P065	6,5mm
	CX38PH1	PH1
	CX38PH2	PH2
	CX38PH3	PH3
	CX38PZ1	PZ1
	CX38PZ2	PZ2
	CX38T10	T10
	CX38T15	T15
	CX38T20	T20
	CX38T25	T25
	CX38T30	T30
	CX38T40	T40
	CX38T45	T45
	CX38T50	T50
	CX38T55	T55

	CX38ET10	E10
	CX38ET11	E11
	CX38ET12	E12
	CX38ET14	E14
	CX38ET16	E16
	CX38ET18	E18
	CX38ET20	E20
	CX38E075	75mm
	CX38E150	150mm
	CX38U38	3/8"
	CX38W	3/8"
	CX38H5	5mm
	CX38H6	6mm
	CX38H7	7mm
	CX38H8	8mm
	CX38H10	10mm



€ 56

CSS03612S

3/8" DOPPENSET LANG 6PT, 12PCS

(M)

	CX38L08	8mm
	CX38L09	9mm
	CX38L10	10mm
	CX38L11	11mm
	CX38L12	12mm
	CX38L13	13mm
	CX38L14	14mm
	CX38L15	15mm
	CX38L16	16mm
	CX38L17	17mm
	CX38L18	18mm
	CX38L19	19mm



€ 35

CSS03012S

3/8" DOPPENSET LANG 12PT, 12PCS

(M)

	CX38L08 12PT	8mm
	CX38L09 12PT	9mm
	CX38L10 12PT	10mm
	CX38L11 12PT	11mm
	CX38L12 12PT	12mm
	CX38L13 12PT	13mm
	CX38L14 12PT	14mm
	CX38L15 12PT	15mm
	CX38L16 12PT	16mm
	CX38L17 12PT	17mm
	CX38L18 12PT	18mm
	CX38L19 12PT	19mm





€ 36

CSP03010S

3/8" (GLOEI-) BOUGIE DOPPENSET, 10PCS

(S)

	CX38BU08	8mm
	CX38BU09	9mm
	CX38BU10	10mm
	CX38BU12	12mm
	CX38BU14	14mm
	CX38BU16	16mm
	CX38B1412PT	14mm, 12 kant/ pans
	CX38B1612PT	16mm, 12 kant/ pans
	CX38B1812PT	18mm, 12 kant/ pans
	CX38B2112PT	21mm, 12 kant/ pans



€ 65

CEB03005S

3/8" SET VERLENGSTUKKEN, 5PCS

(M)

CX38E038	38mm
CX38E075	75mm
CX38E150	150mm
CX38E250	250mm
CX38E450	450mm



€ 33

CTK04022S

1/2" DOPPENSET, 22PCS



CX12K10 10mm	CX12K19 19mm
CX12K11 11mm	CX12K20 20mm
CX12K12 12mm	CX12K21 21mm
CX12K13 13mm	CX12K22 22mm
CX12K14 14mm	CX12K24 24mm
CX12K15 15mm	CX12K27 27mm
CX12K16 16mm	CX12K30 30mm
CX12K17 17mm	CX12K32 32mm
CX12K18 18mm	

CX12E125 125mm
CX12E250 250mm

CX12U12 1/2"

CRHC84472 1/2"

CX38A12 3/8" female
x 1/2" male



€ 77

CSB18018S

1/2" DOPPENSET TORX, 18PCS



L=55mm

CX12T20 T20
CX12T25 T25
CX12T27 T27
CX12T30 T30
CX12T40 T40
CX12T45 T45
CX12T50 T50
CX12T55 T55
CX12T60 T60

L=100mm

CX12T20L T20
CX12T25L T25
CX12T27L T27
CX12T30L T30
CX12T40L T40
CX12T45L T45
CX12T50L T50
CX12T55L T55
CX12T60L T60



€ 58

CSS04613S

1/2" DOPPENSET LANG 6PT, 13PCS



CX12L10 10mm	CX12L19 19mm
CX12L11 11mm	CX12L21 21mm
CX12L12 12mm	CX12L22 22mm
CX12L13 13mm	CX12L24 24mm
CX12L14 14mm	
CX12L15 15mm	
CX12L16 16mm	
CX12L17 17mm	
CX12L18 18mm	

Tevens leverbaar:

CX12L27 27mm
CX12L30 30mm
CX12L32 32mm



€ 42

CSB17018S

1/2" DOPPENSET INBUS, 18PCS



L=55mm

CX12H04S 4mm
CX12H05S 5mm
CX12H06S 6mm
CX12H08S 8mm
CX12H10S 10mm
CX12H12S 12mm
CX12H14S 14mm
CX12H17S 17mm
CX12H19S 19mm

L=100mm

CX12H04L 4mm
CX12H05L 5mm
CX12H06L 6mm
CX12H08L 8mm
CX12H10L 10mm
CX12H12L 12mm
CX12H14L 14mm
CX12H17L 17mm
CX12H19L 19mm



€ 58

CSS04013S

1/2" DOPPENSET LANG 12PT, 13PCS



CX12L10 12PT 10mm	CX12L19 12PT 19mm
CX12L11 12PT 11mm	CX12L21 12PT 21mm
CX12L12 12PT 12mm	CX12L22 12PT 22mm
CX12L13 12PT 13mm	CX12L24 12PT 24mm
CX12L14 12PT 14mm	
CX12L15 12PT 15mm	
CX12L16 12PT 16mm	
CX12L17 12PT 17mm	
CX12L18 12PT 18mm	



€ 44

CEB04005S

1/2" SET VERLENGSTUKKEN, 5PCS



CX12E050 50mm
CX12E070 70mm
CX12E125 125mm
CX12E250 250mm
CX12E375 375mm



€ 37

CWS32418S

STEEKRINGSLEUTELSET, 18PCS

CWS324 006	6mm	CWS324 015	15mm
CWS324 007	7mm	CWS324 016	16mm
CWS324 008	8mm	CWS324 017	17mm
CWS324 009	9mm	CWS324 018	18mm
CWS324 010	10mm	CWS324 019	19mm
CWS324 011	11mm	CWS324 020	20mm
CWS324 012	12mm	CWS324 021	21mm
CWS324 013	13mm	CWS324 022	22mm
CWS324 014	14mm	CWS324 024	24mm



€ 99

(L)

CWS32403S

STEEKRINGSLEUTELSET XL, 3PCS

CWS324 027	27mm
CWS324 030	30mm
CWS324 032	32mm



€ 65

(M)

CWS41112S

STEEKRING RATEL SLEUTELSET, 12PCS

CWS410 108	8mm	CWS410 116	16mm
CWS410 109	9mm	CWS410 117	17mm
CWS410 110	10mm	CWS410 118	18mm
CWS410 111	11mm	CWS410 119	19mm
CWS410 112	12mm	Tevens leverbaar/ livrable: CWS410 121 21mm CWS410 122 22mm CWS410 124 24mm	
CWS410 113	13mm		
CWS410 114	14mm		
CWS410 115	15mm		



€ 115

(M)

CWS41912S

STEEKRING RATEL SLEUTELSET L/R SCHAKELBAAR, 12PCS

CWS419 108	8mm	CWS419 114	14mm
CWS419 109	9mm	CWS419 115	15mm
CWS419 110	10mm	CWS419 116	16mm
CWS419 111	11mm	CWS419 117	17mm
CWS419 112	12mm	CWS419 118	18mm
CWS419 113	13mm	CWS419 119	19mm

L/R-REVERSIBLE



€ 159

(M)

CWS41512S

STEEKRING RATEL SLEUTELSET FLEX, 12PCS

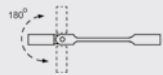

CWS415 108	8mm	CWS415 114	14mm
CWS415 109	9mm	CWS415 115	15mm
CWS415 110	10mm	CWS415 116	16mm
CWS415 111	11mm	CWS415 117	17mm
CWS415 112	12mm	CWS415 118	18mm
CWS415 113	13mm	CWS415 119	19mm



€ 145

(M)

CWS53210S

RINGSLEUTELSET, 10PCS

CWS53 0607	6x7mm	CWS53 1617	16x17mm
CWS53 0809	8x9mm	CWS53 1819	18x19mm
CWS53 1011	10x11mm	CWS53 2022	20x22mm
CWS53 1213	12x13mm	CWS53 2427	24x27mm
CWS53 1415	14x15mm	CWS53 3032	30x32mm



€ 105

(M)

CWS23211S

STEEKSLEUTELSET, 11PCS



CWS232 0607	6x7mm	CWS232 1819	18x19mm
CWS232 0809	8x9mm	CWS232 2022	20x22mm
CWS232 1011	10x11mm	CWS232 2123	21x23mm
CWS232 1213	12x13mm	CWS232 2427	24x27mm
CWS232 1415	14x15mm	CWS232 3032	30x32mm
CWS232 1617	16x17mm		



€ 69,50

CWS23310S

STEEKSLEUTELSET EXTRA DUN, 10 PCS



CWS233 0607	6x7mm	CWS233 1819	18x19mm
CWS233 0809	8x9mm	CWS233 2022	20x22mm
CWS233 1011	10x11mm	CWS233 2123	21x23mm
CWS233 1213	12x13mm	CWS233 2224	22x24mm
CWS233 1415	14x15mm		
CWS233 1617	16x17mm		



€ 79,50

CWS62208S

KNIESLEUTELSET, 8PCS



CWS622 0607	6x7mm
CWS622 0809	8x9mm
CWS622 1011	10x11mm
CWS622 1213	12x13mm
CWS622 1415	14x15mm
CWS622 1617	16x17mm
CWS622 1819	18x19mm
CWS622 2022	20x22mm



€ 79

CWS62410S

PIJPSLEUTELS GEBOGEN, 10PCS



CWS624 008	8mm	CWS624 017	17mm
CWS624 010	10mm	CWS624 018	18mm
CWS624 011	11mm	CWS624 019	19mm
CWS624 012	12mm		
CWS624 013	13mm		
CWS624 014	14mm		
CWS624 016	16mm		



€ 98

CWS42007S

STARTERSLEUTELSET, 7PCS



CWS42 0810	8x10mm
CWS42 1113	11x13mm
CWS42 1214	12x14mm
CWS42 1315	13x15mm
CWS42 1618	16x18mm
CWS42 1719	17x19mm
CWS42 1922	19x22mm



€ 79

CWS62306S

REMLEIDINGSLEUTELSET, 6PCS



CWS623 0810	8x10mm
CWS623 1113	11x13mm
CWS623 1214	12x14mm
CWS623 1617	16x17mm
CWS623 1819	18x19mm
CWS623 2022	20x22mm



€ 46

CSD81214S

SCHROEVENDRAAIERSET, 14PCS



- ⊖ CSD812 30 075 3,0mm L=75mm
- CSD812 35 100 3,5mm L=100mm
- CSD812 40 100 4,0mm L=100mm
- CSD812 55 025 5,5mm L=25mm
- CSD812 55 125 5,5mm L=125mm
- CSD812 65 025 6,5mm L=25mm
- CSD812 65 150 6,5mm L=150mm
- CSD812 80 175 8,0mm L=175mm

- ⊕ CSD812 PH0 060 PH0 L=60mm
- CSD812 PH1 025 PH1 L=25mm
- CSD812 PH1 080 PH1 L=80mm
- CSD812 PH2 025 PH2 L=25mm
- CSD812 PH2 100 PH2 L=100mm
- CSD812 PH3 150 PH3 L=150mm



€ 45

CSD82008S

TORX SCHROEVENDRAAIERSET, 8PCS



- ⊕ CSD820 T08 080 T8 L=60mm
- CSD820 T10 080 T10 L=80mm
- CSD820 T15 080 T15 L=80mm
- CSD820 T20 100 T20 L=100mm
- CSD820 T25 100 T25 L=100mm
- CSD820 T27 115 T27 L=115mm
- CSD820 T30 115 T30 L=115mm
- CSD820 T40 130 T40 L=130mm



€ 37

CSD82112S

SCHROEVENDRAAIERSET MICRO, 12PCS



- ⊖ CSD821 12 400 1,2mm L=40mm
- CSD821 15 400 1,5mm L=40mm
- CSD821 18 400 1,8mm L=40mm
- CSD821 20 600 2,0mm L=60mm
- CSD821 25 600 2,5mm L=60mm
- CSD821 30 600 3,0mm L=60mm
- CSD821 35 600 3,5mm L=60mm
- CSD821 40 600 4,0mm L=60mm

- ⊕ CSD821 PH0 001 PH000 L=60mm
- CSD821 PH0 010 PH00 L=60mm
- CSD821 PH0 100 PH0 L=60mm
- CSD821 PH1 060 PH1 L=60mm



€ 29

CSD81908S

SCHROEVENDRAAIERSET GEÏSOLEERD, 8PCS



- ⊖ CSD819 40 100 4,0mm L=100mm
- CSD819 55 125 5,5mm L=125mm
- CSD819 65 150 6,5mm L=150mm
- CSD819 80 175 8,0mm L=175mm

- ⊕ CSD819 PH1 080 PH1 L=80mm
- CSD819 PH2 100 PH2 L=100mm

- ⊕ CSD819 PZ1 080 PZ1 L=80
- CSD819 PZ2 100 PZ2 L=100



€ 42

CND81709S

DOPSCHROEVENDRAAIER SET, 9PCS



- ⊖ CND817906 6mm L=125mm
- CND817907 7mm L=125mm
- CND817908 8mm L=125mm
- CND817909 9mm L=125mm
- CND817910 10mm L=125mm
- CND817911 11mm L=125mm
- CND817912 12mm L=125mm
- CND817913 13mm L=125mm
- CND817914 14mm L=125mm



€ 56

CKW15008S

INBUS T-HANDLE SET, 8PCS



○	CKW1500 802	2mm	L=100mm
	CKW1500 802S	2,5mm	L=100mm
	CKW1500 803	3mm	L=100mm
	CKW1500 804	4mm	L=150mm
	CKW1500 805	5mm	L=155mm
	CKW1500 806	6mm	L=205mm
	CKW1500 808	8mm	L=205mm
	CKW1500 810	10mm	L=210mm



€ 43

CKW16008S

TORX T-HANDLE SET, 8PCS



⊕	CKW16008 T10H	T10	L=100mm
	CKW16008 T15H	T15	L=100mm
	CKW16008 T20H	T20	L=100mm
	CKW16008 T25H	T25	L=105mm
	CKW16008 T27H	T27	L=105mm
	CKW16008 T30H	T30	L=150mm
	CKW16008 T40H	T40	L=150mm
	CKW16008 T50H	T50	L=150mm



€ 43

CND51309S

T-HANDLE DOPSLEUTELSET, 9PCS



●	CND513 905	5mm	L=230mm
	CND513 906	6mm	L=230mm
	CND513 907	7mm	L=230mm
	CND513 908	8mm	L=230mm
	CND513 909	9mm	L=230mm
	CND513 910	10mm	L=230mm
	CND513 911	11mm	L=230mm
	CND513 912	12mm	L=230mm
	CND513 913	13mm	L=230mm



€ 56

CCP07004S

TANGENSET EXTRA LANG+ KLEMTANG



	CCP070 401	Punttang lang	L=280mm
	CCP070 402	Punttang lang gebogen	L=280mm
	CCP070 403	Bougiekaptang	L=280mm
	CCP070 404	Klemtang	L=170mm



€ 79

CCP08004S

TANGENSET, 4PCS



CCP080401	Punttang lang gebogen
CCP080402	Combinatietang
CCP080403	Punttang lang
CCP080404	Zijkniptang



€ 59

CCP05005S

TANGENSET MINI (ELECTRONICA), 5PCS



CCP050 501	Punttang
CCP050 502	Punttang gebogen
CCP050 503	Zijkniptang
CCP050 504	Kopkniptang
CCP050 505	Striptang



€ 87

CCP06004S
BORGRINGTANGENSET, 4PCS

(S)

-  **CCP060401** Rech, voor inwendige borgringen
-  **CCP060402** Rech, voor uitwendige borgringen
-  **CCP060403** Gebogen, voor uitwendige borgringen
-  **CCP060404** Gebogen, voor inwendige borgringen/



€ 54

CCP10002S
TANGENSET, 2PCS

(S)

-  **CCP10002SLP** Waterpomptang, 250mm
-  **CCP10002SWP** Klemtang, 250mm



€ 37

CCT15003S
MINI ZAAG + SCHARENSET

(M)

-  **CCT150 031** Minizaag
-  **CCT150 032** Schaar universeel, 180mm
-  **CCT150 033** Schaar universeel, 260mm



€ 46

CWS11003S
VERSTELBARE MOERSLEUTEL SET, 3PCS

(S)

- CWS110320** L=200mm Max. 30mm
- CWS110325** L=250mm Max. 33mm
- CWS110330** L=300mm Max. 40mm



€ 66

CFS81005S
VIJLENSET, 5PCS

(M)

-  **CFS810501** Vijl plat
-  **CFS810502** Vijl half rond
-  **CFS810503** Vijl rond
-  **CFS810504** Vijl Vierkant
-  **CFS810505** Vijl driehoek



€ 49,90

CCT14003S
SET MES SCHAAR ZAAG, 3PCS

(M)

-  **CCT140031** Zaag
-  **411012** Zaagblad 24T (1PCS)
(6PCS in CCT14003S)
-  **CCT140033** Mes
-  **CCT140034** Schaar



€ 75

CHP19007S

L

CARROSSERIE UITDEUKSET

- CHP1900 701 Plaatwerkhamer
- CHP1900 702 Lichte krimphamer
- CHP1900 703 Korte punthamer
- CHP1900 704 Dolly, gebogen
- CHP1900 705 Dolly, universeel
- CHP1900 706 Dolly, hiel
- CHP1900 707 Dolly, teen







€ 199

CHP12008S

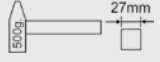
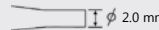
M

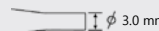
HAMER EN PENDRIJVER SET, 8PCS

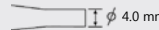
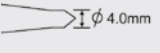
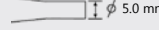
- | | | | | | |
|---|-------|-------------------|---|---------------|-----------|
|  | 27mm | CHP1200801 |  | 412042 | 2 x 140mm |
|  | 35mm | CHP1200802 |  | 412043 | 3 x 150mm |
|  | 16mm | 412030 |  | 412044 | 4 x 180mm |
|  | 4.0mm | 412040 |  | 412045 | 5 x 200mm |



€ 69

CHR67005S

S

BLINDKLINKMOERENTANG

 3/ 4/ 5/ 6/ 8mm

Incl. assortiment blindklinkmoeren

Tevens leverbaar:

- CHR6700513** M3 (100PCS)
- CHR6700514** M4 (100PCS)
- CHR6700515** M5 (100PCS)
- CHR6700516** M6 (100PCS)
- CHR6700518** M8 (100PCS)



€ 52

CHR67004S

S

BLINDKLINKNAGELTANG

 2,4/ 3,2/ 4,0/ 4,8mm



Incl. assortiment popnagels

€ 32

900910 MODULE M lxb=435x180mm

M



€ 9,50

900902 MODULE 1/2M lxb=435x90mm

M



€ 7,50

CMP20007S

S

MEET EN PICK-UP SET, 7 PCS

- 415011** Linaiaal 30cm
- 415012** Schuifmaat
- 415013** Gradenboog
- 415014** Kraspen
- 415015** Pickup tool
- 415016** Telesc. spiegel, 57cm
- 415017** Voelermaat, 20 pcs



€ 79,50

900900 MODULE S lxb=360x145mm

S



€ 8,50

CKW65209S

INBUSSET XL, 9PCS

1,5-2-2,5-3-4-5-6-8-10mm



€ 17

CKW65309S

TORXSET XL, 9PCS

T10-T15-T20-T25-T27-T30-T40-T45-T50



€ 17

CBS21037K

1/4" + 3/8" TORX SET, 37PCS

		CX14ET04 1/4" E4	CX38ET10 3/8" E10
		CX14ET05 1/4" E5	CX38ET11 3/8" E11
		CX14ET06 1/4" E6	CX38ET12 3/8" E12
		CX14ET07 1/4" E7	CX38ET14 3/8" E14
		CX14ET08 1/4" E8	CX38ET16 3/8" E16
			CX38ET18 3/8" E18
			CX38ET20 3/8" E20

	CX38A14 3/8" female x 1/4" male
	CX12A38H 1/2" female x 3/8" male

		CX14BH 1/4" x 6,5mm
		CX38BH 3/8" x 10mm
		CX12BH 1/2" x 10mm

		L= 30mm (x 6,5mm)
		T9/ T10/ T15/ T20 (Zie/ voir CX2006)

		L= 30mm (x 10mm)	L= 75mm (x 10mm)
	CX2137BT 25S T25		CX2137BT 20L T20
	CX2137BT 27S T27		CX2137BT 25L T25
	CX2137BT 30S T30		CX2137BT 27L T27
	CX2137BT 40S T40		CX2137BT 30L T30
	CX2137BT 45S T45		CX2137BT 40L T40
	CX2137BT 50S T50		CX2137BT 45L T45
	CX2137BT 55S T55		CX2137BT 50L T50
			CX2137BT 55L T55
			CX2137BT 60L T60

CBS21044K

3/8" + 1/2" BIT SET, 44PCS

		CX38BH 3/8" (x 10mm)
		CX12BH 1/2" (x 10mm)

		L= 30mm (x 10mm)
		CX2144BTSL8 Plat 8
		CX2144BTSL9 Plat 10

		CX2144BTPH1 PH1
		CX2144BTPH2 PH2
		CX2144BTPH3 PH3

		CX2144BTM05S M5	CX2144BTM10S M10
		CX2144BTM06S M6	CX2144BTM12S M12
		CX2144BTM08S M8	

		L= 30mm (x 10mm)	L= 75mm (x 10mm)
		CX2137BT 20S T20	CX2137BT 20L T20
		CX2137BT 25S T25	CX2137BT 25L T25
		CX2137BT 27S T27	CX2137BT 27L T27
		CX2137BT 30S T30	CX2137BT 30L T30
		CX2137BT 40S T40	CX2137BT 40L T40
		CX2137BT 45S T45	CX2137BT 45L T45
		CX2137BT 50S T50	CX2137BT 50L T50
		CX2137BT 55S T55	CX2137BT 55L T55
		CX2137BT 60S T60	CX2137BT 60L T60

		L= 30mm (x 10mm)	L= 75mm (x 10mm)
		CX3030BT H04 4mm	CX3030BT H04L 4mm
		CX3030BT H05 5mm	CX3030BT H05L 5mm
		CX3030BT H06 6mm	CX3030BT H06L 6mm
		CX3030BT H07 7mm	CX3030BT H07L 7mm
		CX3030BT H08 8mm	CX3030BT H08L 8mm
		CX3030BT H10 10mm	CX3030BT H10L 10mm
		CX3030BT H12 12mm	CX3030BT H12L 12mm



€ 43





€ 43

CTK02037K

1/4" DOPPENSET, 37PCS

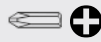
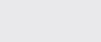
	CX14K04 4mm	CX14K08 8mm	CX14K12 12mm
	CX14K05 5mm	CX14K09 9mm	CX14K13 13mm
	CX14K06 6mm	CX14K10 10mm	CX14K14 14mm
	CX14K07 7mm	CX14K11 11mm	

	PH1 x 6,5mm
	PH2 x 6,5mm
	PH3 x 6,5mm

	4,5mm x 6,5mm
	6,5mm x 6,5mm
	8,0mm x 6,5mm

	3mm x 6,5mm
	4mm x 6,5mm
	5mm x 6,5mm
	6mm x 6,5mm
	7mm x 6,5mm
	8mm x 6,5mm

	CRHC84272 1/4"
--	-----------------------

	T10, T15,
	T20, T25,
	T27, T30,
	T40 (x 6,5mm)

	CX14BH 1/4" x 6,5mm
---	----------------------------

	CX14W 1/4"
---	-------------------

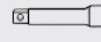
	CX14E050 50mm
	CX14E150 150mm

	CX14U14 1/4"
---	---------------------

	CX14SP 1/4"
---	--------------------



€ 42,50

CTK02027K

1/4" DOPPENSET, 27PCS

	CX14K04 4mm	CX14K08 8mm	CX14K12 12mm
	CX14K05 5mm	CX14K09 9mm	CX14K13 13mm
	CX14K06 6mm	CX14K10 10mm	CX14K14 14mm
	CX14K07 7mm	CX14K11 11mm	

	CX14PH2 PH2
--	--------------------

	CX14T20 T20
	CX14T25 T25
	CX14T27 T27
	CX14T30 T30

	CX14H3 3mm
	CX14H4 4mm
	CX14H5 5mm
	CX14H6 6mm

	CX14P055 5,5mm
--	-----------------------

	CX14W 1/4"
---	-------------------

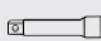
	CX14E050 50mm
	CX14E150 150mm

	CX14U14 1/4"
---	---------------------

	CX14SP 1/4"
---	--------------------

	CRHC84272 1/4"
---	-----------------------



€ 42,50

CTK03030K

3/8" DOPPENSET, 30PCS



CX38K08 8mm
CX38K10 10mm
CX38K11 11mm
CX38K12 12mm
CX38K13 13mm
CX38K14 14mm

CX38K15 15mm
CX38K16 16mm
CX38K17 17mm
CX38K19 19mm
CX38K22 22mm



L= 30mm (x 10mm)
CX2137BT 20S T20
CX2137BT 25S T25
CX2137BT 27S T27
CX2137BT 30S T30
CX2137BT 40S T40
CX2137BT 45S T45
CX2137BT 50S T50



L= 30mm (x 10mm)
CX3030BT H04 4mm
CX3030BT H05 5mm
CX3030BT H06 6mm
CX3030BT H07 7mm
CX3030BT H08 8mm
CX3030BT H10 10mm
CX3030BT H12 12mm



CX38BH 3/8" x 10mm



CX38E075 75mm
CX38E150 150mm



CX12A38 1/2" female x 3/8" male



CRHC84372 3/8"



€ 52

CTK03052K

3/8" DOPPENSET, 52PCS



CX38K06 6mm
CX38K07 7mm
CX38K08 8mm
CX38K09 9mm
CX38K10 10mm
CX38K11 11mm
CX38K12 12mm
CX38K13 13mm
CX38K14 14mm

CX38K15 15mm
CX38K16 16mm
CX38K17 17mm
CX38K18 18mm
CX38K19 19mm
CX38K20 20mm
CX38K21 21mm
CX38K22 22mm



CX38L10 10mm
CX38L12 12mm
CX38L13 13mm

CX38L14 14mm
CX38L17 17mm



CX38PH1 PH1
CX38PH2 PH2
CX38PH3 PH3



CX38H3 3mm
CX38H4 4mm
CX38H5 5mm
CX38H6 6mm
CX38H7 7mm
CX38H8 8mm
CX38H10 10mm



CX38PZ1 PZ1
CX38PZ2 PZ2



CX38T10 T10
CX38T15 T15
CX38T20 T20
CX38T25 T25
CX38T30 T30
CX38T40 T40
CX38T45 T45
CX38T50 T50
CX38T55 T55



CX38P055 5,5mm
CX38P065 6,5mm

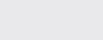

CX38E075 75mm
CX38E150 150mm



CX38U38 3/8"



CX12A38 1/2" female x 3/8" male



CX38B16 16mm
CX38B21 21mm



CRHC84372 3/8"



€ 88

CTK03025K

3/8" GEREEDSCHAPSSET INCH, 25PCS



CX38KN06 3/8"
CX38KN08 7/16"
CX38KN10 1/2"
CX38KN12 9/16"
CX38KN14 5/8"
CX38KN16 11/16"
CX38KN18 3/4"
CX38KN20 13/16"
CX38KN22 7/8"



CRHC84372 3/8"



CX38E075 75mm
CX38E150 150mm



CX38U38 3/8"



CWS302502 1/4"
CWS302504 5/16"
CWS302506 3/8"
CWS302508 7/16"
CWS302510 1/2"
CWS302512 9/16"
CWS302514 5/8"
CWS302516 11/16"
CWS302518 3/4"
CWS302520 13/16"
CWS302522 7/8"
CWS302524 15/16"



INCH



€ 109

CTK02498K

1/4" + 1/2" DOPPENSET, 98PCS



CX14K04 1/4" 4mm
CX14K045 1/4" 4,5mm
CX14K05 1/4" 5mm
CX14K055 1/4" 5,5mm
CX14K06 1/4" 6mm
CX14K07 1/4" 7mm
CX14K08 1/4" 8mm
CX14K09 1/4" 9mm
CX14K10 1/4" 10mm
CX14K11 1/4" 11mm
CX14K12 1/4" 12mm
CX14K13 1/4" 13mm

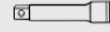

CX14E075 1/4" 75mm
CX14E150 1/4" 150mm



CX14U14 1/4"



CX14SP 1/4"

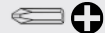

PH3, PH4 (x 8mm)



8, 10, 12mm (x 8mm)



10, 12, 14mm (x 8mm)



T45, T50, T55 (x 8mm)

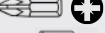

PZ3, PZ4 (x 8mm)



CX38A14 3/8" female
 - 1/4" male



CX14L06 1/4" 6mm
CX14L07 1/4" 7mm
CX14L08 1/4" 8mm
CX14L09 1/4" 9mm
CX14L10 1/4" 10mm
CX14L11 1/4" 11mm
CX14L12 1/4" 12mm
CX14L13 1/4" 13mm



CX14ET06 1/4" E6
CX14ET07 1/4" E7
CX14ET08 1/4" E8
CX14ET10 1/4" E10
CX14ET11 1/4" E11



CX14PH1 1/4" PH1
CX14PH2 1/4" PH2

CX12ET12 1/2" E12
CX12ET14 1/2" E14
CX12ET16 1/2" E16
CX12ET18 1/2" E18
CX12ET20 1/2" E20



CX14P04 1/4" 4mm
CX14P055 1/4" 5,5mm
CX14P065 1/4" 6,5mm



CX12K10 1/2" 10mm
CX12K11 1/2" 11mm
CX12K12 1/2" 12mm
CX12K13 1/2" 13mm
CX12K14 1/2" 14mm
CX12K15 1/2" 15mm
CX12K16 1/2" 16mm
CX12K17 1/2" 17mm
CX12K18 1/2" 18mm
CX12K19 1/2" 19mm
CX12K20 1/2" 20mm
CX12K21 1/2" 21mm
CX12K22 1/2" 22mm
CX12K24 1/2" 24mm
CX12K27 1/2" 27mm
CX12K30 1/2" 30mm
CX12K32 1/2" 32mm



CX14PZ1 1/4" PZ1
CX14PZ2 1/4" PZ2



CX14H3 1/4" 3mm
CX14H4 1/4" 4mm
CX14H5 1/4" 5mm
CX14H6 1/4" 6mm
CX14H8 1/4" 8mm



CX14T10 1/4" T10
CX14T15 1/4" T15
CX14T20 1/4" T20
CX14T25 1/4" T25
CX14T27 1/4" T27
CX14T30 1/4" T30
CX14T40 1/4" T40



CX12L14 1/2" 14mm
CX12L15 1/2" 15mm
CX12L17 1/2" 17mm
CX12L19 1/2" 19mm
CX12L22 1/2" 22mm



CX12B16 1/2" 16mm
CX12B21 1/2" 21mm



CX12E125 125mm
CX12E250 250mm



CX12BHH 1/2" x 8mm



CX12U12 1/2"



CX38A12 3/8" female- 1/2" male





CRHC84272 1/4"
CRHC84472 1/2"

€ 159

CTK02472K

1/4" + 1/2" DOPPENSET, 72PCS

	CX14K04 1/4" 4mm
	CX14K045 1/4" 4,5mm
	CX14K05 1/4" 5mm
	CX14K055 1/4" 5,5mm
	CX14K06 1/4" 6mm
	CX14K07 1/4" 7mm
	CX14K08 1/4" 8mm
	CX14K09 1/4" 9mm
	CX14K10 1/4" 10mm
	CX14K11 1/4" 11mm
	CX14K12 1/4" 12mm
	CX14K13 1/4" 13mm

	CX14L06 1/4" 6mm
	CX14L07 1/4" 7mm
	CX14L08 1/4" 8mm
	CX14L09 1/4" 9mm
	CX14L10 1/4" 10mm
	CX14L11 1/4" 11mm
	CX14L12 1/4" 12mm
	CX14L13 1/4" 13mm

	CX14PH1 1/4" PH1
	CX14PH2 1/4" PH2

	CX14P04 1/4" 4mm
	CX14P055 1/4" 5,5mm
	CX14P065 1/4" 6,5mm

	CX14PZ1 1/4" PZ1
	CX14PZ2 1/4" PZ2

	CX14H3 1/4" 3mm
	CX14H4 1/4" 4mm
	CX14H5 1/4" 5mm
	CX14H6 1/4" 6mm
	CX14H8 1/4" 8mm

	CX14T10 1/4" T10
	CX14T15 1/4" T15
	CX14T20 1/4" T20
	CX14T25 1/4" T25
	CX14T30 1/4" T30
	CX14T40 1/4" T40

	CX12K10 1/2" 10mm
	CX12K11 1/2" 11mm
	CX12K12 1/2" 12mm
	CX12K13 1/2" 13mm
	CX12K14 1/2" 14mm
	CX12K15 1/2" 15mm
	CX12K16 1/2" 16mm
	CX12K17 1/2" 17mm
	CX12K18 1/2" 18mm
	CX12K19 1/2" 19mm
	CX12K20 1/2" 20mm
	CX12K21 1/2" 21mm
	CX12K22 1/2" 22mm
	CX12K24 1/2" 24mm
	CX12K27 1/2" 27mm
	CX12K30 1/2" 30mm
	CX12K32 1/2" 32mm

	CX12L14 1/2" 14mm
	CX12L15 1/2" 15mm
	CX12L17 1/2" 17mm
	CX12L19 1/2" 19mm
	CX12L22 1/2" 22mm

	CX14E050 1/4" 50mm
	CX14E100 1/4" 100mm

	CX12E125 1/2" 125mm
	CX12E250 1/2" 250mm

	CX14SP 1/4"
---	--------------------

	CX14U14 1/4"
	CX12U12 1/2"

	CX12B16 1/2" 16mm
	CX12B21 1/2" 21mm

	CX38A12 3/8" female - 1/2" male
---	--

	CRHC84272 1/4"
	CRHC84472 1/2"





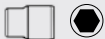

€ 135

CTK02483S

GEREEDSCHAPSKOFFER, 83 PCS

-  **CX14K04** 1/4" 4mm
- CX14K045** 1/4" 4,5mm
- CX14K05** 1/4" 5mm
- CX14K055** 1/4" 5,5mm
- CX14K06** 1/4" 6mm
- CX14K07** 1/4" 7mm
- CX14K08** 1/4" 8mm
- CX14K09** 1/4" 9mm
- CX14K10** 1/4" 10mm
- CX14K11** 1/4" 11mm
- CX14K12** 1/4" 12mm
- CX14K13** 1/4" 13mm



-  **CX14BH** 1/4" x 6,5mm
-  **CX14SP** 1/4"
-  **CX14E075** 1/4" 75mm
- CX14E150** 1/4" 150mm
- CX12E125** 1/2" 125mm

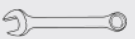

-  **CX38A14** 3/8" - 1/4"
- CX38A12** 3/8" - 1/2"

-  **CX14U14** 1/4"
- CX12U12** 1/2"

-  **CRHC84272** 1/4"
- CRHC84472** 1/2"

-  **CWS324007** 7mm
- CWS324008** 8mm
- CWS324009** 9mm
- CWS324010** 10mm
- CWS324011** 11mm
- CWS324012** 12mm
- CWS324013** 13mm
- CWS324014** 14mm
- CWS324015** 15mm
- CWS324017** 17mm
- CWS324019** 19mm

- CX2002**
-  SL3, 4, 5, 6, 7 (6,5mm)
-  H3, 4, 5, 6, 7, 8 (6,5mm)

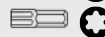
- CX2001**
-  PH1, 2, 3 (6,5mm)
-  PZ1, 2, 3 (6,5mm)
-  T10, 15, 20, 25, 30 (6,5mm)

-  **CX12K13** 1/2" 13mm
- CX12K14** 1/2" 14mm
- CX12K15** 1/2" 15mm
- CX12K16** 1/2" 16mm
- CX12K17** 1/2" 17mm
- CX12K18** 1/2" 18mm
- CX12K19** 1/2" 19mm
- CX12K22** 1/2" 22mm
- CX12K24** 1/2" 24mm
- CX12K27** 1/2" 27mm

- CX12B16** 1/2" 16mm
- CX12B21** 1/2" 21mm

 **CHP1200801**

 **CCT150031**

 **CCT140033**

 **CCT140034**

 **CCP10002SLP**

 **CCP080403**

 **CCP080402**

 **CWS 110320**

-  **CSD812 40 100** 4,0mm L=100mm
- CSD812 55 025** 5,5mm L=25mm
- CSD812 55 125** 5,5mm L=125mm

-  **CSD812 PH1 025** PH1 L=25mm
- CSD812 PH1 080** PH1 L=80mm
- CSD812 PH2 100** PH2 L=100mm

 **CTK0248301** Rolmeter, 5mtr

 **CTK0248302** Spanningzoeker 110/250V



€ 239

CTK02494K

GEREEDSCHAPSKOFFER IN FOAM INCL GEREEDSCHAP, 94PCS

1/4" en 1/2" Ratels en doppen, E torx doppen, bougiedoppen, verlengstukken, kniestukken, bits PH, PZ, torx, inbus, plat, adapters, steekringsleutels, diverse tangen, waterpomptang, verstelbare moersleutel, schroevendraaiers, spanning-zoeker, mes, schaar, rolmaat, zaag, platte vijl, pendrijvers, beitel, hamer. LxBxH: 470x220x250mm







**FOAM
MODULES**

€ 359

CTK06014K

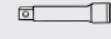
3/4" DOPPENSET, 14PCS





	CX34K22 22mm		CRHA83548 3/4"
	CX34K24 24mm		
	CX34K27 27mm		CX34E100 3/4" 100mm
	CX34K30 30mm		CX34E200 3/4" 200mm
	CX34K32 32mm		
	CX34K36 36mm		CX34W 3/4"
	CX34K38 38mm		
	CX34K41 41mm		
	CX34K46 46mm		
	CX34K50 50mm		



€ 145

CTK08015K

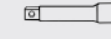
1" DOPPENSET, 15PCS

	CX10K36 36mm		CRHA83624 1"
	CX10K41 41mm		
	CX10K46 46mm		CX10E200 1" 200mm
	CX10K50 50mm		CX10E400 1" 400mm
	CX10K55 55mm		
	CX10K60 60mm		CX10AD 1"
	CX10K65 65mm		
	CX10K70 70mm		
	CX10K75 75mm		
	CX10K80 80mm		



€ 349

BITS

6,5mm (l= 25mm)

CX2001	PH1-2-3, PZ1-2-3, T10-15-20-25-30	€ 12,50
CX2002	Plat SL3-4-5-6, Inbus H3-4-5-6-7-8	€ 12,50
CX2003	Inbus H3-4-5-6-7-8 (6dlg)	€ 10,00
CX2004	Plat SL4,5- 6,5- 8 (3dlg)	€ 7,50
CX2005	PH1-2-3	€ 7,50
CX2006	T10-T15-T20-T25-T27-T30-T40	€ 11,00
CX14BH	Bithouder (1/4" x 6,5mm)	€ 4,90

10mm (l= 30mm)

CX2137BT15S	Torx T15	€ 3,50
CX2137BT20S	Torx T20	€ 3,50
CX2137BT25S	Torx T25	€ 3,50
CX2137BT27S	Torx T27	€ 3,50
CX2137BT30S	Torx T30	€ 3,50
CX2137BT40S	Torx T40	€ 3,50
CX2137BT45S	Torx T45	€ 3,50
CX2137BT50S	Torx T50	€ 3,50
CX2137BT55S	Torx T55	€ 3,50
CX2137BT60S	Torx T60	€ 3,50

CX3030BTH04	Inbus H4	€ 4,20
CX3030BTH05	Inbus H5	€ 4,20
CX3030BTH06	Inbus H6	€ 4,20

CX3030BTH07	Inbus H7	€ 4,20
CX3030BTH08	Inbus H8	€ 4,20
CX3030BTH10	Inbus H10	€ 4,20
CX3030BTH12	Inbus H12	€ 4,20

BITS 10mm (l= 75mm)

CX2137BT20L	Torx T20 lang	€ 4,20
CX2137BT25L	Torx T25 lang	€ 4,20
CX2137BT27L	Torx T27 lang	€ 4,20
CX2137BT30L	Torx T30 lang	€ 4,20
CX2137BT40L	Torx T40 lang	€ 4,20
CX2137BT45L	Torx T45 lang	€ 4,20
CX2137BT50L	Torx T50 lang	€ 4,20
CX2137BT55L	Torx T55 lang	€ 4,20
CX2137BT60L	Torx T60 lang	€ 4,20

CX3030BTH04L	Inbus H4 lang	€ 4,80
CX3030BTH05L	Inbus H5 lang	€ 4,80
CX3030BTH06L	Inbus H6 lang	€ 4,80
CX3030BTH07L	Inbus H7 lang	€ 4,80
CX3030BTH08L	Inbus H8 lang	€ 4,80
CX3030BTH10L	Inbus H10 lang	€ 4,80
CX3030BTH12L	Inbus H12 lang	€ 4,80

BITHOUDERS

CX38BH	Bithouder (3/8" x10mm)	€ 5,00
CX12BH	Bithouder (1/2" x10mm)	€ 5,00

ONDERDELEN 1/4"

CX14K04	1/4" dop 4mm	€ 4,60
CX14K04S	1/4" dop 4,5mm	€ 4,60
CX14K05	1/4" dop 5mm	€ 4,60
CX14K05S	1/4" dop 5,5mm	€ 4,60
CX14K06	1/4" dop 6mm	€ 4,60
CX14K07	1/4" dop 7mm	€ 4,60
CX14K08	1/4" dop 8mm	€ 4,60
CX14K09	1/4" dop 9mm	€ 4,60
CX14K10	1/4" dop 10mm	€ 4,60
CX14K11	1/4" dop 11mm	€ 4,60
CX14K12	1/4" dop 12mm	€ 4,60
CX14K13	1/4" dop 13mm	€ 4,80
CX14K14	1/4" dop 14mm	€ 5,00

CX14L04	1/4" dop 4mm, lang	€ 5,30
CX14L05	1/4" dop 5mm, lang	€ 5,30
CX14L06	1/4" dop 6mm, lang	€ 5,30
CX14L07	1/4" dop 7mm, lang	€ 5,30
CX14L08	1/4" dop 8mm, lang	€ 5,30
CX14L09	1/4" dop 9mm, lang	€ 5,30
CX14L10	1/4" dop 10mm, lang	€ 5,30
CX14L11	1/4" dop 11mm, lang	€ 5,30
CX14L12	1/4" dop 12mm, lang	€ 5,30
CX14L13	1/4" dop 13mm, lang	€ 5,30
CX14L14	1/4" dop 14mm, lang	€ 5,50

CX14L0412PT	1/4" dop 4mm 12-kant, lang	€ 5,60
CX14L0512PT	1/4" dop 5mm 12-kant, lang	€ 5,60
CX14L0612PT	1/4" dop 6mm 12-kant, lang	€ 5,60
CX14L0712PT	1/4" dop 7mm 12-kant, lang	€ 5,60
CX14L0812PT	1/4" dop 8mm 12-kant, lang	€ 5,60
CX14L0912PT	1/4" dop 9mm 12-kant, lang	€ 5,60
CX14L1012PT	1/4" dop 10mm 12-kant, lang	€ 5,60
CX14L1112PT	1/4" dop 11mm 12-kant, lang	€ 5,60
CX14L1212PT	1/4" dop 12mm 12-kant, lang	€ 5,60
CX14L1312PT	1/4" dop 13mm 12-kant, lang	€ 5,60
CX14L1412PT	1/4" dop 14mm 12-kant, lang	€ 5,90

CX14T10	1/4" dop T10	€ 4,90
CX14T15	1/4" dop T15	€ 4,90
CX14T20	1/4" dop T20	€ 4,90
CX14T25	1/4" dop T25	€ 4,90
CX14T27	1/4" dop T27	€ 4,90
CX14T30	1/4" dop T30	€ 4,90
CX14T40	1/4" dop T40	€ 4,90

CX14H3	1/4" dop H3	€ 4,60
CX14H4	1/4" dop H4	€ 4,60
CX14H5	1/4" dop H5	€ 4,60
CX14H6	1/4" dop H6	€ 4,60
CX14H8	1/4" dop H8	€ 4,60

CX14PH1	1/4" dop PH1	€ 4,90
CX14PH2	1/4" dop PH2	€ 4,90

CX14PZ1	1/4" dop PZ1	€ 4,90
CX14PZ2	1/4" dop PZ2	€ 4,90

CX14P04	1/4" dop plat 4mm	€ 4,90
CX14P055	1/4" dop plat 5,5mm	€ 4,90
CX14P065	1/4" dop plat 6,5mm	€ 4,90

CX14ET04	1/4" dop E4	€ 5,50
CX14ET05	1/4" dop E5	€ 5,50
CX14ET06	1/4" dop E6	€ 5,50
CX14ET07	1/4" dop E7	€ 5,50
CX14ET08	1/4" dop E8	€ 5,50
CX14ET10	1/4" dop E10	€ 5,50
CX14ET11	1/4" dop E11	€ 5,50

CX14E050	1/4" verlengstuk 50mm	€ 4,90
CX14E075	1/4" verlengstuk 75mm	€ 5,60
CX14E100	1/4" verlengstuk 100mm	€ 5,60
CX14E150	1/4" verlengstuk 150mm	€ 6,40
CX14U14	1/4" kniestuk	€ 6,50
CX14SP	1/4" schroevendraaier	€ 7,20
CX14W	1/4" wringijzer	€ 6,80

1/4"

ONDERDELEN 3/8"

3/8"

CX38K06	3/8" dop 6mm	€ 5,30
CX38K07	3/8" dop 7mm	€ 5,30
CX38K08	3/8" dop 8mm	€ 5,30
CX38K09	3/8" dop 9mm	€ 5,30
CX38K10	3/8" dop 10mm	€ 5,30
CX38K11	3/8" dop 11mm	€ 5,30
CX38K12	3/8" dop 12mm	€ 5,30
CX38K13	3/8" dop 13mm	€ 5,30
CX38K14	3/8" dop 14mm	€ 5,30
CX38K15	3/8" dop 15mm	€ 5,80
CX38K16	3/8" dop 16mm	€ 5,80
CX38K17	3/8" dop 17mm	€ 5,80
CX38K18	3/8" dop 18mm	€ 5,80
CX38K19	3/8" dop 19mm	€ 5,80
CX38K20	3/8" dop 20mm	€ 6,50
CX38K21	3/8" dop 21mm	€ 6,50
CX38K22	3/8" dop 22mm	€ 6,50

CX38L08	3/8" dop 8mm, lang	€ 6,00
CX38L09	3/8" dop 9mm, lang	€ 6,00
CX38L10	3/8" dop 10mm, lang	€ 6,00
CX38L11	3/8" dop 11mm, lang	€ 6,00
CX38L12	3/8" dop 12mm, lang	€ 6,00
CX38L13	3/8" dop 13mm, lang	€ 6,00
CX38L14	3/8" dop 14mm, lang	€ 6,00
CX38L15	3/8" dop 15mm, lang	€ 6,00
CX38L16	3/8" dop 16mm, lang	€ 6,80
CX38L17	3/8" dop 17mm, lang	€ 6,80
CX38L18	3/8" dop 18mm, lang	€ 7,40
CX38L19	3/8" dop 19mm, lang	€ 7,40

CX38L0812PT	3/8" dop 8mm 12-k, lang	€ 7,30
CX38L0912PT	3/8" dop 9mm 12-k, lang	€ 7,30
CX38L1012PT	3/8" dop 10mm 12-kant, lang	€ 7,30
CX38L1112PT	3/8" dop 11mm 12-kant, lang	€ 7,30
CX38L1212PT	3/8" dop 12mm 12-kant, lang	€ 7,30
CX38L1312PT	3/8" dop 13mm 12-kant, lang	€ 7,30
CX38L1412PT	3/8" dop 14mm 12-kant, lang	€ 7,30
CX38L1512PT	3/8" dop 15mm 12-kant, lang	€ 7,30
CX38L1612PT	3/8" dop 16mm 12-kant, lang	€ 7,30
CX38L1712PT	3/8" dop 17mm 12-kant, lang	€ 7,30
CX38L1812PT	3/8" dop 18mm 12-kant, lang	€ 7,90
CX38L1912PT	3/8" dop 19mm 12-kant, lang	€ 7,90

CX38T10	3/8" dop T10	€ 5,80
CX38T15	3/8" dop T15	€ 5,80
CX38T20	3/8" dop T20	€ 5,80
CX38T25	3/8" dop T25	€ 5,80
CX38T30	3/8" dop T30	€ 5,80
CX38T40	3/8" dop T40	€ 5,80
CX38T45	3/8" dop T45	€ 6,20
CX38T50	3/8" dop T50	€ 6,20
CX38T55	3/8" dop T55	€ 6,20

CX38H3	3/8" dop H3	€ 5,90
CX38H4	3/8" dop H4	€ 5,90
CX38H5	3/8" dop H5	€ 5,90
CX38H6	3/8" dop H6	€ 5,90
CX38H7	3/8" dop H7	€ 5,90
CX38H8	3/8" dop H8	€ 5,90
CX38H10	3/8" dop H10	€ 6,20

CX38PH1	3/8" dop PH1	€ 5,80
CX38PH2	3/8" dop PH2	€ 5,80
CX38PH3	3/8" dop PH3	€ 5,80

CX38PZ1	3/8" dop PZ1	€ 5,80
CX38PZ2	3/8" dop PZ2	€ 5,80

CX38P055	3/8" dop Plat 5,5mm	€ 6,00
CX38P065	3/8" dop Plat 6,5mm	€ 6,00

CX38ET10	3/8" dop E10	€ 5,50
CX38ET11	3/8" dop E11	€ 5,50
CX38ET12	3/8" dop E12	€ 5,50
CX38ET14	3/8" dop E14	€ 5,50
CX38ET16	3/8" dop E16	€ 5,50
CX38ET18	3/8" dop E18	€ 6,00
CX38ET20	3/8" dop E20	€ 7,00

CX38E038	3/8" verlengstuk 38mm	€ 5,00
CX38E075	3/8" verlengstuk 75mm	€ 6,30
CX38E150	3/8" verlengstuk 150mm	€ 7,80
CX38E250	3/8" verlengstuk 250mm	€ 9,60
CX38E450	3/8" verlengstuk 450mm	€ 14,50

CX38B16	3/8" bougiedop 16mm	€ 6,90
CX38B21	3/8" bougiedop 21mm	€ 7,50
CX38A14	3/8"-1/4" Adaptor	€ 4,90
CX38A12	3/8"-1/2" Adaptor	€ 7,50
CX38U38	3/8" kniestuk	€ 7,70
CX38W	3/8" wringijzer	€ 9,00

CX38B1412PT	3/8" bougiedop 14mm, 12 kant	€ 7,50
CX38B1612PT	3/8" bougiedop 16mm, 12 kant	€ 7,50
CX38B1812PT	3/8" bougiedop 18mm, 12 kant	€ 7,90
CX38B2112PT	3/8" bougiedop 21mm, 12 kant	€ 7,90

CX38BU08	3/8" bougiedop 8mm, knie	€ 16,50
CX38BU09	3/8" bougiedop 9mm, knie	€ 16,50
CX38BU10	3/8" bougiedop 10mm, knie	€ 16,50
CX38BU12	3/8" bougiedop 12mm, knie	€ 16,50
CX38BU14	3/8" bougiedop 14mm, knie	€ 16,50
CX38BU16	3/8" bougiedop 16mm, knie	€ 16,50



ONDERDELEN 1/2"

CX12K10	1/2" dop 10mm	€ 5,00
CX12K11	1/2" dop 11mm	€ 5,00
CX12K12	1/2" dop 12mm	€ 5,00
CX12K13	1/2" dop 13mm	€ 5,00
CX12K14	1/2" dop 14mm	€ 5,00
CX12K15	1/2" dop 15mm	€ 5,00
CX12K16	1/2" dop 16mm	€ 5,00
CX12K17	1/2" dop 17mm	€ 6,00
CX12K18	1/2" dop 18mm	€ 6,00
CX12K19	1/2" dop 19mm	€ 6,00
CX12K20	1/2" dop 20mm	€ 6,50
CX12K21	1/2" dop 21mm	€ 6,50
CX12K22	1/2" dop 22mm	€ 6,50
CX12K24	1/2" dop 24mm	€ 6,50
CX12K27	1/2" dop 27mm	€ 8,00
CX12K30	1/2" dop 30mm	€ 9,80
CX12K32	1/2" dop 32mm	€ 9,80

CX12L10	1/2" dop 10mm, lang	€ 7,00
CX12L11	1/2" dop 11mm, lang	€ 7,00
CX12L12	1/2" dop 12mm, lang	€ 7,00
CX12L13	1/2" dop 13mm, lang	€ 7,00
CX12L14	1/2" dop 14mm, lang	€ 7,00
CX12L15	1/2" dop 15mm, lang	€ 7,00
CX12L16	1/2" dop 16mm, lang	€ 7,00
CX12L17	1/2" dop 17mm, lang	€ 7,00
CX12L18	1/2" dop 18mm, lang	€ 7,50
CX12L19	1/2" dop 19mm, lang	€ 7,50
CX12L21	1/2" dop 21mm, lang	€ 7,50
CX12L22	1/2" dop 22mm, lang	€ 7,50
CX12L24	1/2" dop 24mm, lang	€ 9,00
CX12L27	1/2" dop 27mm, lang	€ 10,50
CX12L30	1/2" dop 30mm, lang	€ 12,00
CX12L32	1/2" dop 32mm, lang	€ 12,50

CX12L1012PT	1/2" dop 10mm 12-k, lang	€ 7,60
CX12L1112PT	1/2" dop 11mm 12-k, lang	€ 7,60
CX12L1212PT	1/2" dop 12mm 12-k, lang	€ 7,60
CX12L1312PT	1/2" dop 13mm 12-kant, lang	€ 7,60
CX12L1412PT	1/2" dop 14mm 12-kant, lang	€ 7,60
CX12L1512PT	1/2" dop 15mm 12-kant, lang	€ 8,20
CX12L1612PT	1/2" dop 16mm 12-kant, lang	€ 8,20
CX12L1712PT	1/2" dop 17mm 12-kant, lang	€ 8,20
CX12L1812PT	1/2" dop 18mm 12-kant, lang	€ 8,20
CX12L1912PT	1/2" dop 19mm 12-kant, lang	€ 8,20
CX12L2112PT	1/2" dop 21mm 12-kant, lang	€ 8,50
CX12L2212PT	1/2" dop 22mm 12-kant, lang	€ 9,50
CX12L2412PT	1/2" dop 24mm 12-kant, lang	€ 9,50

CX12T20	1/2" dop torx T20	€ 6,90
CX12T25	1/2" dop torx T25	€ 6,90
CX12T27	1/2" dop torx T27	€ 6,90
CX12T30	1/2" dop torx T30	€ 6,90
CX12T40	1/2" dop torx T40	€ 6,90
CX12T45	1/2" dop torx T45	€ 6,90
CX12T50	1/2" dop torx T50	€ 6,90
CX12T55	1/2" dop torx T55	€ 6,90
CX12T60	1/2" dop torx T60	€ 6,90

CX12T20L	1/2" dop torx T20, 100mm	€ 8,50
CX12T25L	1/2" dop torx T25, 100mm	€ 8,50
CX12T27L	1/2" dop torx T27, 100mm	€ 8,50
CX12T30L	1/2" dop torx T30, 100mm	€ 8,50
CX12T40L	1/2" dop torx T40, 100mm	€ 8,50
CX12T45L	1/2" dop torx T45, 100mm	€ 8,50
CX12T50L	1/2" dop torx T50, 100mm	€ 8,50
CX12T55L	1/2" dop torx T55, 100mm	€ 8,50
CX12T60L	1/2" dop torx T60, 100mm	€ 8,50



CX12H04S	1/2" dop inbus H4	€ 6,80
CX12H05S	1/2" dop inbus H5	€ 6,80
CX12H06S	1/2" dop inbus H6	€ 6,80
CX12H08S	1/2" dop inbus H8	€ 6,80
CX12H10S	1/2" dop inbus H10	€ 6,80
CX12H12S	1/2" dop inbus H12	€ 6,80
CX12H14S	1/2" dop inbus H14	€ 6,80
CX12H17S	1/2" dop inbus H17	€ 7,80
CX12H19S	1/2" dop inbus H19	€ 8,40

CX12H04L	1/2" dop inbus H4, 100mm	€ 7,50
CX12H05L	1/2" dop inbus H5, 100mm	€ 7,50
CX12H06L	1/2" dop inbus H6, 100mm	€ 7,50
CX12H07L	1/2" dop inbus H7, 100mm	€ 7,50
CX12H08L	1/2" dop inbus H8, 100mm	€ 7,50
CX12H10L	1/2" dop inbus H10, 100mm	€ 7,50
CX12H12L	1/2" dop inbus H12, 100mm	€ 7,50
CX12H14L	1/2" dop inbus H14, 100mm	€ 7,50
CX12H17L	1/2" dop inbus H17, 100mm	€ 9,50
CX12H19L	1/2" dop inbus H19, 100mm	€ 11,00

CX12ET12	1/2" dop E-torx 12	€ 6,00
CX12ET14	1/2" dop E-torx 14	€ 6,00
CX12ET16	1/2" dop E-torx 16	€ 6,00
CX12ET18	1/2" dop E-torx 18	€ 6,00
CX12ET20	1/2" dop E-torx 20	€ 6,00

CX12E050	1/2" verlengstuk 50mm	€ 6,00
CX12E070	1/2" verlengstuk 70mm	€ 6,80
CX12E125	1/2" verlengstuk 125mm	€ 10,50
CX12E250	1/2" verlengstuk 250mm	€ 15,00
CX12E375	1/2" verlengstuk 375mm	€ 19,90

CX12B16	1/2" bougiedop 16mm	€ 7,00
CX12B21	1/2" bougiedop 21mm	€ 7,60
CX12A38	1/2"-3/8" Adaptor (met gat)	€ 7,50
CX12U12	1/2" kniestuk	€ 9,50



1/2"



ONDERDELEN 3/4"

3/4"

CX34K22	3/4" dop 22mm	€ 10,20
CX34K24	3/4" dop 24mm	€ 10,20
CX34K27	3/4" dop 27mm	€ 10,40
CX34K30	3/4" dop 30mm	€ 11,80
CX34K32	3/4" dop 32mm	€ 12,50
CX34K36	3/4" dop 36mm	€ 15,80
CX34K38	3/4" dop 38mm	€ 17,00
CX34K41	3/4" dop 41mm	€ 21,50
CX34K46	3/4" dop 46mm	€ 22,50
CX34K50	3/4" dop 50mm	€ 24,00

CRHA83548 3/4" ratel € 39,00

CX34E100 3/4" verlengstuk 100mm € 16,60
CX34E200 3/4" verlengstuk 200mm € 23,00

CX34W 3/4" wringijzer € 28,50

ONDERDELEN 1"

1"

CX10K36	1" dop 36mm	€ 19,00
CX10K41	1" dop 41mm	€ 20,50
CX10K46	1" dop 46mm	€ 27,00
CX10K50	1" dop 50mm	€ 29,00
CX10K55	1" dop 55mm	€ 36,00
CX10K60	1" dop 60mm	€ 39,00
CX10K65	1" dop 65mm	€ 43,00
CX10K70	1" dop 70mm	€ 46,00
CX10K75	1" dop 75mm	€ 49,50
CX10K80	1" dop 80mm	€ 51,50

CRHA83624 1" ratel € 132,50

CX10E200 1" verlengstuk 200mm € 46,50
CX10E400 1" verlengstuk 400mm € 64,00

CX10AD 1" wringijzer € 19,00

SLEUTELS



CWS324006	Steekringsleutel 6mm	€ 6,40
CWS324007	Steekringsleutel 7mm	€ 6,40
CWS324008	Steekringsleutel 8mm	€ 6,40
CWS324009	Steekringsleutel 9mm	€ 6,40
CWS324010	Steekringsleutel 10mm	€ 6,90
CWS324011	Steekringsleutel 11mm	€ 7,20
CWS324012	Steekringsleutel 12mm	€ 7,80
CWS324013	Steekringsleutel 13mm	€ 8,20
CWS324014	Steekringsleutel 14mm	€ 9,00
CWS324015	Steekringsleutel 15mm	€ 10,20
CWS324016	Steekringsleutel 16mm	€ 10,20
CWS324017	Steekringsleutel 17mm	€ 11,20
CWS324018	Steekringsleutel 18mm	€ 12,00
CWS324019	Steekringsleutel 19mm	€ 12,60
CWS324020	Steekringsleutel 20mm	€ 13,80
CWS324021	Steekringsleutel 21mm	€ 17,00
CWS324022	Steekringsleutel 22mm	€ 18,50
CWS324024	Steekringsleutel 24mm	€ 20,50
CWS324027	Steekringsleutel 27mm	€ 27,00
CWS324030	Steekringsleutel 30mm	€ 32,00
CWS324032	Steekringsleutel 32mm	€ 36,00



CWS530607	Ringsleutel gebogen 6x7mm	€ 9,50
CWS530809	Ringsleutel gebogen 8x9mm	€ 10,50
CWS531011	Ringsleutel gebogen 10x11mm	€ 12,00
CWS531213	Ringsleutel gebogen 12x13mm	€ 13,50
CWS531415	Ringsleutel gebogen 14x15mm	€ 15,50
CWS531617	Ringsleutel gebogen 16x17mm	€ 17,50
CWS531819	Ringsleutel gebogen 18x19mm	€ 19,00
CWS532022	Ringsleutel gebogen 20x22mm	€ 22,00
CWS532427	Ringsleutel gebogen 24x27mm	€ 27,50
CWS533032	Ringsleutel gebogen 30x32mm	€ 36,50



CWS6220607	Kniesleutel 6x7mm	€ 11,00
CWS6220809	Kniesleutel 8x9mm	€ 11,00
CWS6221011	Kniesleutel 10x11mm	€ 12,00
CWS6221213	Kniesleutel 12x13mm	€ 12,20
CWS6221415	Kniesleutel 14x15mm	€ 14,00
CWS6221617	Kniesleutel 16x17mm	€ 17,00
CWS6221819	Kniesleutel 18x19mm	€ 19,00
CWS6222022	Kniesleutel 20x22mm	€ 27,50



CWS419108	Steekringratelsleutel L/R, 8mm	€ 18,00
CWS419109	Steekringratelsleutel L/R, 9mm	€ 18,00
CWS419110	Steekringratelsleutel L/R, 10mm	€ 18,00
CWS419111	Steekringratelsleutel L/R, 11mm	€ 19,50
CWS419112	Steekringratelsleutel L/R, 12mm	€ 19,50
CWS419113	Steekringratelsleutel L/R, 13mm	€ 21,00
CWS419114	Steekringratelsleutel L/R, 14mm	€ 22,00
CWS419115	Steekringratelsleutel L/R, 15mm	€ 23,50
CWS419116	Steekringratelsleutel L/R, 16mm	€ 23,50
CWS419117	Steekringratelsleutel L/R, 17mm	€ 26,50
CWS419118	Steekringratelsleutel L/R, 18mm	€ 28,00
CWS419119	Steekringratelsleutel L/R, 19mm	€ 29,50



TANGEN

CCP080401	Gebogen punttang	€ 24,00
CCP080402	Combinatietang	€ 22,00
CCP080403	Punttang	€ 23,00
CCP080404	Zijkniptang	€ 23,00



BORGRINGTANGEN

CCP060401	Borgringtang recht, tbv inw. borgringen	€ 19,00
CCP060402	Borgringtang recht, tbv uitw. borgringen	€ 19,00
CCP060403	Borgringtang gebogen, tbv uitw. borgringen	€ 19,00
CCP060404	Borgringtang gebogen, tbv inw. borgringen	€ 19,00



SCHROEVENDRAAIERS

CSD812 30 075	Schroevendraaier plat 3x 75mm	€ 6,50
CSD812 35 100	Schroevendraaier plat 3,5x 100mm	€ 6,50
CSD812 40 100	Schroevendraaier plat 4x 100mm	€ 6,50
CSD812 55 025	Schroevendraaier plat 5,5x 25mm	€ 6,50
CSD812 55 125	Schroevendraaier plat 5,5x 125mm	€ 6,50
CSD812 65 025	Schroevendraaier plat 6,5x 25mm	€ 6,50
CSD812 65 150	Schroevendraaier plat 6,5x 150mm	€ 7,80
CSD812 80 175	Schroevendraaier plat 8x 175mm	€ 9,20

CSD812 PH0 060	Schroevendraaier PH0x 60mm	€ 6,50
CSD812 PH1 025	Schroevendraaier PH1x 25mm	€ 6,50
CSD812 PH1 080	Schroevendraaier PH1x 80mm	€ 6,50
CSD812 PH2 025	Schroevendraaier PH2x 25mm	€ 6,50
CSD812 PH2 100	Schroevendraaier PH2x 100mm	€ 7,80
CSD812 PH3 150	Schroevendraaier PH3x 150mm	€ 9,20

CSD820 T08 080	Torx schroevendraaier T8 x 60	€ 6,50
CSD820 T10 080	Torx schroevendraaier T10 x 80	€ 7,30
CSD820 T15 080	Torx schroevendraaier T15 x 80	€ 7,30
CSD820 T20 100	Torx schroevendraaier T20 x 100	€ 7,30
CSD820 T25 100	Torx schroevendraaier T25 x 100	€ 7,80
CSD820 T27 115	Torx schroevendraaier T27 x 115	€ 7,80
CSD820 T30 115	Torx schroevendraaier T30 x 115	€ 7,80
CSD820 T40 130	Torx schroevendraaier T40 x 130	€ 9,00



T-SLEUTELS

CKW1500 802	Inbus T-Sleutel 2mm x 100	€ 6,50
CKW1500 8025	Inbus T-Sleutel 2,5mm x 100	€ 6,50
CKW1500 803	Inbus T-Sleutel 3mm x 100	€ 6,50
CKW1500 804	Inbus T-Sleutel 4mm x 150	€ 7,00
CKW1500 805	Inbus T-Sleutel 5mm x 155	€ 7,00
CKW1500 806	Inbus T-Sleutel 6mm x 205	€ 8,50
CKW1500 808	Inbus T-Sleutel 8mm x 205	€ 10,00
CKW1500 810	Inbus T-Sleutel 10mm x 210	€ 11,50

CKW16008 T10H	Torx T-Sleutel T10 x100	€ 6,50
CKW16008 T15H	Torx T-Sleutel T15 x100	€ 6,50
CKW16008 T20H	Torx T-Sleutel T20 x100	€ 6,90
CKW16008 T25H	Torx T-Sleutel T25 x105	€ 7,00
CKW16008 T27H	Torx T-Sleutel T27 x105	€ 7,20
CKW16008 T30H	Torx T-Sleutel T30 x150	€ 8,20
CKW16008 T40H	Torx T-Sleutel T40 x150	€ 8,60
CKW16008 T50H	Torx T-Sleutel T50 x150	€ 10,40



ALGEMENE VERKOOPVOORWAARDEN DELTA INTERNATIONAL B.V.

ARTIKEL 1 – TOEPASSELIJKHEID VOORWAARDEN

Deze voorwaarden gelden voor iedere aanbieder en iedere overeenkomst tussen Delta International B.V., hierna te noemen: "DELTA" en een koper waarop DELTA deze voorwaarden van toepassing heeft verklaard.

ARTIKEL 2 – OFFERTES

Alle aanbiedingen zijn steeds vrijblijvend. Een aanbieder is gedurende de in de offerte genoemde termijn geldig. Na het verstrijken van de termijn is de vrijblijvende aanbieding van rechtswege vervallen en kan er geen beroep meer op worden gedaan.

Overeenkomsten komen eerst tot stand nadat de bestelling en/of opdracht van de koper hetzij schriftelijk is bevestigd door DELTA hetzij de koper de offerte of de orderbevestiging voor akkoord heeft ondertekend en aan DELTA heeft toegezonden hetzij feitelijk is uitgevoerd door DELTA.

De in de catalogi, prijslijsten, brochures en andere algemene bescheiden van DELTA opgenomen gegevens en/of afbeeldingen zijn indicatief. De koper kan daaraan geen rechten ontleen.

De in een offerte opgenomen prijzen zijn exclusief BTW en exclusief transportkosten, tenzij anders aangegeven.

ARTIKEL 3 – TECHNISCHE EISEN

Het door DELTA geleverde programma werkplaatsuitrusting is CE gecertificeerd en voldoet net als de overige te leveren zaken aan de in de offerte omschreven technische eisen binnen de gebruikelijke toleranties.

ARTIKEL 4 – GARANTIE

DELTA garandeert dat de door haar geleverde zaken vrij zijn van ontwerp-, materiaal- en fabricagefouten gedurende een periode van twee jaar na levering. Indien de zaak een ontwerp-, materiaal- of fabricagefout vertoont, heeft de koper recht op herstel van de zaak. DELTA kan ervoor kiezen de zaak te vervangen indien herstel op bezwaren stuit. De koper heeft slechts recht op vervanging indien herstel van de zaak niet mogelijk is.

De garantie geldt niet indien schade het gevolg is van een onjuiste behandeling. Onder onjuiste behandeling wordt onder meer verstaan: schade ten gevolge van het niet in acht nemen van de gebruikershandleiding, schade ten gevolge van normale slijtage, overbelasting en onoordeelkundig gebruik.

ARTIKEL 5 – LEVERING EN LEVERTIJD

Levering geschiedt af fabriek dan wel af magazijn van DELTA.

Het transport geschiedt alleen dan voor rekening van DELTA indien dit in de offerte dan wel in de prijslijst uitdrukkelijk is aangegeven. Het risico van het tenietgaan en/of beschadiging, diefstal et cetera van de te leveren zaken tijdens het transport is voor risico van DELTA.

De koper is verplicht de gekochte zaken af te nemen op het moment waarop deze hem worden bezorgd dan wel op het moment waarop deze volgens de overeenkomst aan hem ter beschikking worden gesteld. Indien de koper de afname weigert of nalatig is met het verstrekken van informatie of instructies, noodzakelijk voor de levering, zullen de zaken worden opgeslagen voor risico van de koper. De koper zal in dat geval alle aanvullende kosten, waaronder in ieder geval de opslag- en extra transportkosten, verschuldigd zijn.

De opgegeven levertijden zijn geen fatale termijnen, tenzij uitdrukkelijk anders is overeengekomen. Bij niet tijdige levering dient DELTA schriftelijk door de koper in gebreke te worden gesteld, waarbij DELTA een redelijke termijn wordt gegeven om alsnog na te komen. DELTA is bij overschrijding van de levertijd, behalve in het geval van overmacht, alleen dan verplicht de schade van de koper te vergoeden wanneer haar voor die te late levering volgens de wet een verwijt kan worden gemaakt. Overschrijding van de overeengekomen levertijd geeft de koper alleen dan het recht ontbinding van de overeenkomst in te roepen, nadat de koper eerst schriftelijk, bij aangetekende brief, DELTA heeft meegedeeld dat zij in verzuim is, waarbij DELTA een redelijke termijn wordt toegestaan om alsnog aan haar leveringsverplichting te kunnen voldoen. Het is DELTA toegestaan de verkochte zaken in gedeelten te leveren. Indien de zaken in gedeelten worden geleverd, is DELTA bevoegd elk gedeelte afzonderlijk te factureren.

ARTIKEL 6 – EIGENDOMSVOORBEHOUD

Alle aan de koper geleverde of te leveren zaken blijven eigendom van DELTA totdat de koper alle verplichtingen, ook die ten aanzien van boeten, kosten en schadevergoeding, uit alle met DELTA gesloten (koop)overeenkomsten is nagekomen.

Door DELTA afgeleverde zaken, die onder het eigendomsvoorbehoud vallen, mogen slechts in het kader van een normale bedrijfsuitoefening worden doorverkocht. Overigens is de koper niet bevoegd de zaken te verpanden of hier enig ander recht op te vestigen.

ARTIKEL 7 – BETALING

Betaling dient te geschieden binnen 30 dagen na factuurdatum, tenzij schriftelijk een andere betalingstermijn is overeengekomen, door middel van overschrijving van het verschuldigde bedrag naar het op de factuur aangegeven rekeningnummer ten name van Delta International BV.

Na het verstrijken van de betalingstermijn is de koper in verzuim; de koper is vanaf het moment van in verzuim treden over het opeisbare bedrag contractuele rente verschuldigd van 1,5% per maand. Indien de koper in gebreke of in verzuim is met het nakomen van een of meer van zijn verplichtingen dan is de koper gehouden alle incassokosten, zowel gerechtelijke als buitengerechtelijke, te vergoeden. De buitengerechtelijke (incasso) kosten belopen 15% van het factuurbedrag met een minimum van EUR 500,=.

In geval van liquidatie, faillissement of surséance van betaling van de koper zijn de verplichtingen van de koper onmiddellijk opeisbaar.

Door de koper gedane betalingen strekken steeds ter afdoening in de eerste plaats van alle verschuldigde rente en kosten, en in de tweede plaats van opeisbare facturen, die het langst openstaan, zelfs al vermeldt de koper dat de voldoening betrekking heeft op een latere factuur.

ARTIKEL 8 – GEBREKEN EN KLACHTEN

De koper dient de gekochte zaken bij aflevering, of zo spoedig daarna als mogelijk, te (laten) onderzoeken. Hierbij dient de koper na te gaan of het geleverde aan de overeenkomst beantwoordt, te weten a) of de juiste zaken zijn geleverd, b) of de afgeleverde zaken wat betreft kwantiteit overeenstemmen met hetgeen overeengekomen en c) of de afgeleverde zaken voldoen aan de overeengekomen technische eisen.

Worden zichtbare gebreken of tekorten geconstateerd, dan dient de koper deze binnen vijf werkdagen na ontdekking schriftelijk aan DELTA te melden. Niet-zichtbare gebreken dient de koper binnen vijf werkdagen na ontdekking, doch uiterlijk binnen één jaar na aflevering, schriftelijk te melden aan DELTA.

ARTIKEL 9 – PROCEDURE BIJ KLACHTEN

Indien de koper meent dat sprake is van ontwerp-, materiaal- dan wel fabricagefouten, dan dient hij dit binnen vijf werkdagen na ontdekking schriftelijk te melden aan DELTA en de geleverde zaken omgaand voor zijn rekening en risico terug te zenden aan DELTA.

ARTIKEL 10 – AANSPRAKELIJKHEID

Lid 1: DELTA is jegens de koper uitsluitend aansprakelijk voor schade als gevolg van gebreken in geleverde zaken zoals geregeld in artikel 8 en 9 van deze voorwaarden. DELTA is, indien er sprake is van een gebrek in de geleverde zaken, nimmer aansprakelijk voor enige gevolgschade, zoals bedrijfsschade, die de koper lijdt door het gemis van de zaken gedurende enige tijd of anderszins. Voor alle andere schade is DELTA evenmin aansprakelijk.

Lid 2: Indien ter kennis van de koper komt, dat zich met een door DELTA geleverde zaak een voorval voordoet, dat leidt tot productaansprakelijkheid als bedoeld in artikel 6:185 BW, dient de koper hiervan omgaand, doch uiterlijk op de eerste werkdag dat hij van het voorval kennis krijgt, per e-mail bericht te geven aan DELTA, onder zo nauwkeurig mogelijke opgave van type van het product en de omstandigheden waaronder het feit zich heeft voorgedaan.

Lid 3: Indien de koper nalaat aan DELTA bericht te geven conform het vorige lid, verbeurt hij een boete van EUR 5.000,=, onverminderd het recht van DELTA om, indien de daadwerkelijke schade die zij lijdt ten gevolge van het niet-melden van het voorval hoger is, de daadwerkelijke schade te verhalen.

Lid 4: De koper is, indien zich een voorval als bedoeld in het vorige lid voordoet, verplicht het gebruik van alle vergelijkbare producten (producten met hetzelfde catalogusnummer) onmiddellijk te staken en deze voor controle terug te zenden naar DELTA, dan wel een naar keuze van DELTA technische deskundige in de gelegenheid te stellen ter plaatse polshoogte te nemen, dan wel een door DELTA aangewezen deskundige derde in de gelegenheid te stellen de producten te onderzoeken.

Lid 5: Indien de koper de verplichting onder artikel 10 lid 2 t/m artikel 10 lid 4 niet nakomt en er doet zich hernieuwd een voorval voor als bedoeld in artikel 10 lid 2 met een product met hetzelfde catalogusnummer, dient de koper DELTA tegen aanspraken van derden ter zake te vrijwaren.

Lid 6: Indien de koper de zaken niet voor haar bedrijfsvoering gebruikt, doch er sprake is van wederverkoop aan bedrijven of particulieren, dient de koper verkoop van producten met hetzelfde catalogusnummer als het product die de schade heeft veroorzaakt onmiddellijk te staken en de afnemers, die producten uit dezelfde serie hebben ontvangen onmiddellijk van het voorval op de hoogte te stellen en DELTA tevens in de gelegenheid te stellen al het mogelijke te doen de veiligheid van de zich in voorraad bevindende producten en de reeds onder de afnemers verspreide producten te onderzoeken, conform de in het vorige lid gegeven regeling. De artikelen 10 lid 3 en artikel 10 lid 5 zijn van overeenkomstige toepassing.

ARTIKEL 11 – OVERMACHT

Indien de overeenkomst door DELTA niet of slechts gedeeltelijk kan worden nagekomen als gevolg van overmacht wordt de overeenkomst hetzij met onmiddellijke ingang door een schriftelijke verklaring ontbonden hetzij de uitvoering van de overeenkomst opgeschort met de duur van de overmacht, zonder dat een plicht tot schadevergoeding ontstaat.

Indien DELTA bij het intreden van de overmacht al gedeeltelijk aan haar verplichtingen heeft voldaan, of slechts gedeeltelijk aan haar verplichtingen kan voldoen, is zij gerechtigd het al geleverde c.q. het leverbare deel afzonderlijk te factureren en is de koper gehouden deze factuur te voldoen als het betrof het een afzonderlijk contract. Dit geldt echter niet als het reeds geleverde c.q. leverbare deel geen zelfstandige waarde heeft.

ARTIKEL 12 – TOEPASSELIJKE RECHT EN BEVOEGDE RECHTER

Alle geschillen voortvloeiende uit overeenkomsten tussen DELTA en de koper worden beslecht door de rechtbank 's-Hertogenbosch althans door de rechtbank 's-Hertogenbosch, sector kanton, locatie Eindhoven.

Op elke overeenkomst tussen DELTA en de koper is Nederlands recht van toepassing en met uitzondering met van het Weens Koopverdrag.

Gedeponeerd bij de Kamer van Koophandel Brabant onder nummer 17119778.

